



L'Evoluzione della Sicurezza

SICUREZZA
STARK
PORTE BLINDATE - SECURITY DOORS





SIGUREZZA
STARK
PORTE BLINDATE - SECURITY DOORS

Welcome home!

Non ha importanza il posto dove abiti, l'importante è sentirsi sempre a casa. E ciò che ci fa sentire a casa non è quanto ci circonda, ma trovarsi nel posto dove ci sono le cose e le persone che più amiamo, le più preziose per noi! E tutto questo deve essere al sicuro, sempre e ad ogni costo: solo allora ci sentiremo davvero a casa!



#Stark protegge il presente guardando al futuro



Fin dal 1994 in Stark batte forte la passione per la sicurezza! L'azienda di Barge (CN), infatti, ogni anno produce porte blindate al 100% Made in Italy, utilizzando materiali di primissima qualità. Su una superficie di circa 15mila mq, Stark realizza con cura sartoriale svariati modelli di porte blindate grazie all'ausilio di macchinari all'avanguardia e all'alta professionalità della forza lavoro.

Nascono, così, prodotti "su misura" e totalmente certificati: antieffrazione (Classi 4, 3 e 2), isolamento acustico, isolamento termico, tenuta aria, acqua e vento, ma non solo. All'affidabilità tecnica delle sue realizzazioni e di ogni componente, Stark abbina un'attenzione costante alle più recenti evoluzioni del design, per fornire soluzioni adatte ad ogni tipo di ambiente residenziale o professionale.



È nata una gamma di prodotti rinnovata ed ampliata, in grado di ritagliarsi uno spazio importante anche nei segmenti alti e medio-alti del mercato.





Introduzione



L'azienda Stark.....	4
Come scegliere la porta blindata.....	8
Ambienti.....	10
Classe antieffrazione.....	22
Isolamento acustico.....	23
Isolamento termico.....	23

Le collezioni



EXCLUSIVE.....	26
----------------	----



STYLE.....	38
------------	----



PROJECT.....	50
--------------	----

Le caratteristiche

Serrature.....	66
Cilindri.....	82
Maniglie.....	90
Vetri.....	96
Passate.....	104
Soglie.....	108

I rivestimenti



Alum.....	118
Alum-light.....	126



Techline.....	128
Fiberline.....	136



Glass.....	140
Woodline.....	146



Sky.....	150
Cross.....	154
Corner.....	158
Classic.....	164



Stone.....	168
Rustici.....	170



Surface.....	172
Chrome.....	178
Concept.....	184
Reset.....	188
Living.....	192
Easy.....	194
Laminate.....	196



Assembly.....	200
Rilievi.....	202
Intarsi.....	203
Pensiline.....	204

Come scegliere la porta blindata

La scelta del modello di porta blindata da acquistare non passa solo attraverso il proprio gusto estetico ed il livello di sicurezza, ma sono diverse le valutazioni da fare per identificare la porta più adatta per la nostra casa. Nello schema vengono mostrati tutti gli elementi che compongono un blindato STARK. Ogni componente ha molteplici varianti, sceglierli con giudizio può fare la differenza. Ambiente esterno, grado di sicurezza, design, serratura ed isolamento termico ed acustico sono gli elementi da considerare per fare la giusta scelta.

AMBIENTE

Sapere in che ambiente verrà installata la porta è il primo fattore da tener presente per la scelta del rivestimento esterno e la tipologia di isolamento necessario.

SICUREZZA

Il livello di sicurezza è determinato dalla classe di antieffrazione della porta e da eventuali optional su serrature e cilindri.

SERRATURE

Le serrature ed i cilindri, oltre ad essere importanti per il livello di sicurezza, determinano le modalità di utilizzo e funzionamento della porta.

RIVESTIMENTI

La scelta del rivestimento può essere differente tra esterno ed interno. Se per l'esterno bisogna valutare il tipo di esposizione ambientale, per quello interno basta il proprio gusto estetico. I rivestimenti STARK sono disponibili in diversi materiali, dall'alluminio al PVC, dal vetro al legno, dalla resina al laminato, con innumerevoli finiture e colori.

ISOLAMENTO

Tutte le porte blindate Stark sono realizzate con un doppio strato di materiale isolante all'interno della struttura dell'anta, per garantire un ottimo isolamento termico ed acustico, e di conseguenza un ottimo risparmio energetico a tutto vantaggio del confort e del rispetto ambientale.

RIVESTIMENTO ESTERNO

Il rivestimento esterno deve essere scelto in base al tipo di esposizione agli agenti atmosferici e successivamente in base ai gusti estetici personali. Per ogni linea di rivestimento è indicato il tipo di esposizione consigliata, le prestazioni termiche e le relative garanzie.

MANIGLIE

Una ampia scelta di maniglie che permette di personalizzare il design della porta. In caso di fattori ambientali avversi (salsedine, umidità, nebbia, ecc.) si consiglia l'utilizzo di finiture adatte all'esterno come PVD o Acciaio INOX.

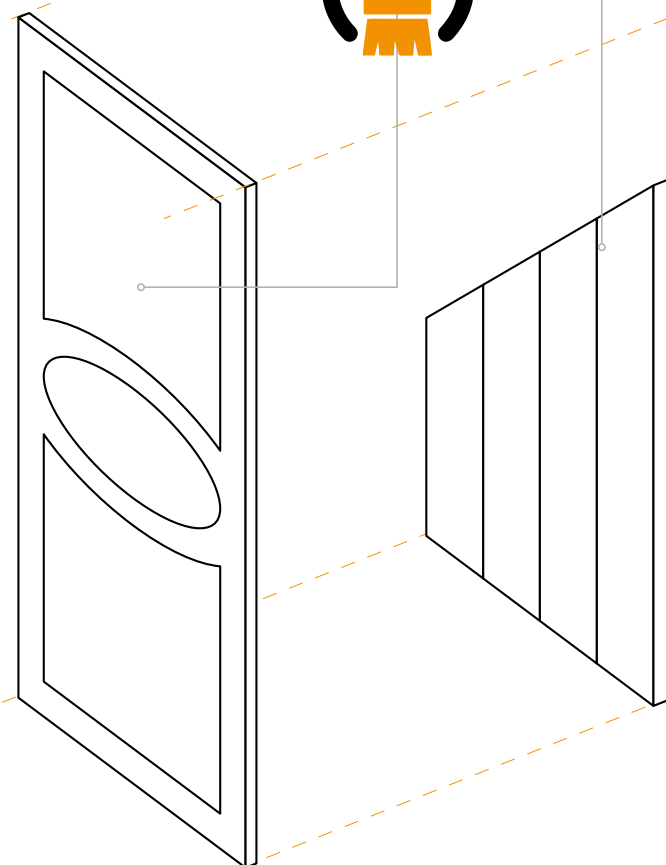
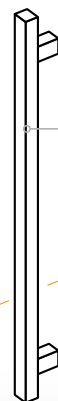

CERNIERE

A seconda della collezione le porte sono equipaggiate con cerniere a scomparsa (Collezione EXCLUSIVE), non visibili a porta chiusa, per un design più lineare e moderno, o con cerniere di tipo tradizionale (Collezioni STYLE e PROJECT).

STRUTTURA

La struttura dell'anta realizzata in lastre di acciaio saldate, è una delle componenti fondamentali per determinare la classe anti effrazione e quindi la resistenza della porta.

CILINDRI

La scelta del cilindro deve essere effettuata in base al grado di sicurezza e alle caratteristiche di utilizzo e funzionalità.

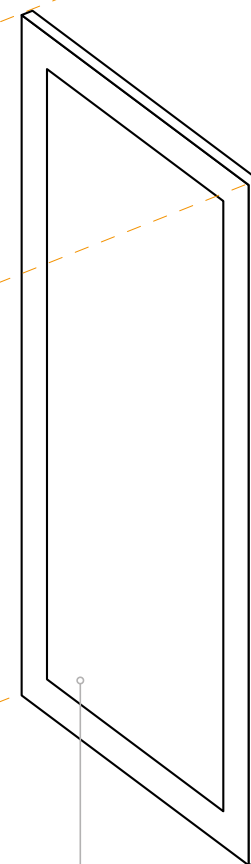
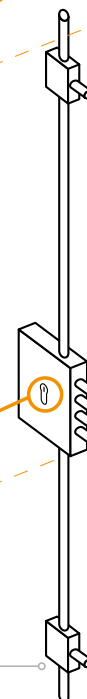
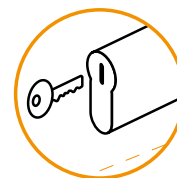
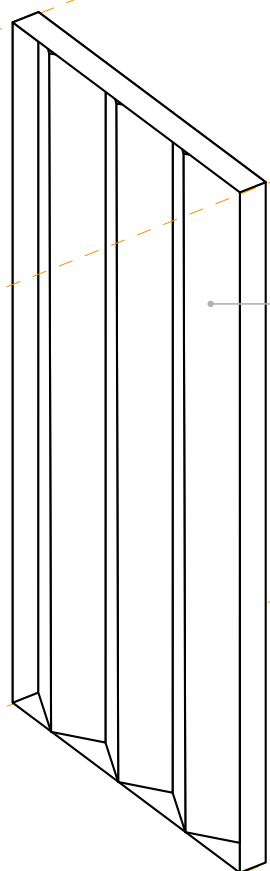

SOGLIA

Oltre al paraspiffero a discesa (di serie su tutti i modelli) sono disponibili diverse tipologie di soglie a terra che permettono di migliorare le prestazioni di tenuta acqua/aria e di isolamento acustico.

TELAIO

Il telaio e il controtelaio realizzati in robusta lamiera piegata rappresentano l'elemento di congiunzione tra la porta e la muratura esistente. Le differenti tipologie di telaio permettono di adattarsi alle più svariate esigenze di posa in opera.



SERRATURE

Le serrature possono essere "single", "doppie" con sistema padronale/servizio o con "funzionamento elettronico" che permette di operare sulla porta con dispositivi diversi dalla chiave classica.



RIVESTIMENTO INTERNO

Il rivestimento interno non essendo condizionato da limiti tecnici legati all'esposizione ambientale, è scelto solo per motivi estetici e di design.



#clima

Non mi fai né caldo né freddo!

Intemperie e condizioni climatiche critiche possono mettere a dura prova le porte e gli infissi esterni degli edifici. Ecco perché in caso di porte in luoghi dal **clima rigido** o direttamente a **contatto con la pioggia** o, ancora, **esposte ai raggi solari** e a **brusche correnti d'aria**, è importante scegliere molto attentamente su quale prodotto indirizzarsi.





Preferire, anzitutto, rivestimenti per esterno con **buone prestazioni termiche**. Da questo punto di vista le varianti **Fiberline** o **Techline** offrono un miglioramento aggiuntivo e di sicuro affidamento, oltre a garantire un'ottima resistenza in caso di esposizione agli agenti atmosferici.



Effettuare la posa con **telaio a filo lato esterno** o realizzare **coperture con profilatura** del telaio su lato interno ed esterno, per ridurre la conduzione termica del telaio.



Scegliere **soglie a terra in alluminio** che garantiscono un miglioramento della resistenza ad aria, acqua e vento. Il rivenditore suggerirà il modello di soglia più indicato in base alle condizioni ambientali e di posa specifiche.

Blindato Stark Linea EXCLUSIVE
con rivestimento TECHLINE - PV34



#umidità

Preferisco stare all'asciutto!

In ambienti molto umidi perché vicini a **mare, laghi** o **corsi d'acqua** o semplicemente a causa della frequente presenza di **nebbie** o **foschie**, la scelta di una porta esterna va presa focalizzando la propria attenzione nell'individuare i **rivestimenti** e le **maniglie** più adatti.





Blindato Stark LineaSTYLE
con rivestimento ALUM - AF4-A



Prediligere rivestimenti per esterno con **ottima resistenza** agli agenti atmosferici. I rivestimenti delle serie **Alum** o **Class** sono le soluzioni migliori, con **garanzia fino a 10 anni** anche in presenza di salsedine. Garantiscono, inoltre, **facilità di manutenzione** in quanto semplici da lavare. Anche le varianti **Fiberline** o **Techline** assicurano ottime prestazioni e una **garanzia fino a 5 anni**; sono tuttavia meno indicate in caso di salsedine.



Scegliere **maniglie in acciaio inox** o con trattamento **PVD**, perché molto più adatte in condizioni di elevata umidità oltre ad offrire un'elevata e durevole protezione superficiale dalla corrosione e dai graffi.



#sicurezza

Io non rischio!

Sempre più spesso, purtroppo, occorre **mettere al riparo** la propria abitazione o azienda dal rischio di furti o effrazioni. Ecco quindi che la scelta del modello di porta va effettuata prestando particolare attenzione al **certificato antieffrazione**, che ne indica la resistenza a tentativi di scasso. Numerosi sono gli accorgimenti proposti per garantire ai propri spazi il massimo livello di sicurezza grazie all'ausilio di **porte blindate**.



Blindato Stark Linea STYLE
con rivestimento STONE - PT8



Certificazione antieffrazione classe 4, **doppie serrature** con meccanismo interbloccante e **blocca aste elettronico** (in caso di scasso della serratura impedisce lo sblocco dei punti di chiusura superiore), sono solo alcuni degli elementi da considerare quando si decide quale porta mettere a difesa di ciò a cui si tiene di più: la propria tranquillità e sicurezza.



È consigliabile, inoltre, preferire **serrature con dispositivo a trappola** che scattano bloccando le maniglie se si tenta di estrarre o rompere il cilindro con porta in sicurezza, o montare sensori di allarme nel telaio, collegabili a un qualsiasi impianto antifurto.



Tutti i modelli di porte blindate Stark adottano il **Defender conico**, un ottimo rimedio per la difesa del cilindro. Per aumentare il livello di sicurezza, è possibile installare un **Defender rotativo magnetico**, che impedisce l'attacco sull'innesto chiave ed evita eventuali atti vandalici, o uno **allarmato**, che in caso di attacco sul defender esterno fa scattare un antifurto. Fondamentale, infine, è anche la scelta dei **cilindri** che possono elevare il grado di sicurezza con una duplicazione protetta e controllata delle chiavi.



#design

Amo la bellezza!

Se l'abitazione oltre ad essere di pregio è dotata anche di un'elevata componente di design e automazione, la porta blindata non può essere solo sicura, ma anche esclusiva dal punto di vista estetico.





Una **serratura elettronica Smart** o **Zeus** sposa alla perfezione design e tecnologia, si può optare per i **modelli Exclusive** dotati di **cerniere a scomparsa** e pose a **filo muro** (interne ed esterne) che ne esaltano la linea moderna.



Anche la scelta della maniglia ha la sua importanza e, su tutte, la più indicata è la maniglia quadra, sul lato interno, mentre sull'esterno è consigliabile l'utilizzo di **maniglioni** disponibili di varie lunghezze.



La **gamma di rivestimenti**, sia interni che esterni, infine, è molto vasta e con ulteriori possibilità di personalizzazione, specie se la porta non è direttamente a contatto con agenti atmosferici.

Blindato Stark Linea EXCLUSIVE
con rivestimento GLASS GL-S5



#pregio

Appartamento o ufficio, decido io chi entra!

In caso di **appartamenti di pregio** o **uffici** abbinati a un'elevata componente di **design**, è possibile spaziare su tutta la gamma di rivestimenti, ma è opportuno comunque valutare con attenzione il tipo di **serratura** e prendere in considerazione soluzioni che tengano conto delle esigenze di **gestione degli accessi**.



Blindato Stark Linea EXCLUSIVE
con rivestimento SKY MS16



Prediligere modelli con **cerniere a scomparsa (linea Exclusive)** e possibilità di posa a **filo muro**, sia sul lato interno che su quello esterno.

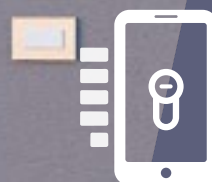

Si consiglia di valutare l'utilizzo di **doppie serrature** con chiave padronale e di servizio, utili soprattutto per abitazioni private con personale di servizio o studi professionali con collaboratori/dipendenti. La **serratura elettronica Smart** garantisce, inoltre, ulteriore automazione e controllo degli accessi.



Anche l'occhio, però, vuole la sua parte. Ecco quindi che i **rivestimenti interni** possono essere **coordinati con le porte presenti** nell'ambiente, anche con l'applicazione di coperture del **telaio in tinta**, per ridurne l'impatto estetico. È a disposizione l'intera gamma di rivestimenti per il lato esterno.



L'installazione di **cilindri con chiavi ad accesso combinato** semplifica, infine, l'ingresso a passaggi comuni o ad accessi multipli per ogni singolo appartamento.



#classico

Appartamento classico,
ho l'imbarazzo della scelta!

Per porte di appartamenti in **condomini classici**
non esistono limitazioni particolari ed è possi-
bile scegliere in massima libertà su tutta la **va-
sta gamma di modelli**, accessori e rivestimenti.





Blindato Stark Linea STYLE
con rivestimento ASSEMBLY EB3



La presenza di vincoli estetici non è da considerare come un problema: è possibile, infatti, fornire **rivestimento e passata personalizzati**, per mantenere fede al design del complesso abitativo.



Anche in questo caso l'installazione di **cilindri con chiavi ad accesso combinato** semplifica l'ingresso a passaggi comuni o ad accessi multipli per ogni singolo appartamento.

CLASSI DI EFFRAZIONE

Tutte le porte blindate STARK sono certificate secondo le normative europee antieffrazione che le classifica secondo il loro grado di resistenza allo scasso. Il grado di sicurezza della porta è acquisito in base al superamento di prove di scasso altamente selettive realizzate da preposti laboratori ed istituti di certificazione ufficialmente riconosciuti. Solo i prodotti certificati antieffrazione possono garantire la qualità e assicurare il grado di resistenza. La STARK ha certificato tutti i suoi prodotti per garantire ai suoi clienti i massimi standard qualitativi. La norma richiede che il campione sia sottoposto per la qualificazione a tre tipi di prove di resistenza:

• CARICO STATICO (definite dalla UNI ENV 1628:2000) • CARICO DINAMICO (definite dalla UNI ENV 1629:2000) • AZIONE MANUALE DI EFFRAZIONE (definite dalla UNI ENV 1630:2000).

Oltre ai livelli di sicurezza certificati ci sono diversi particolari di serie (Defender conico, Scatola protezione mandate serratura, Scelta di un cilindro con elevate prestazioni) o opzionali (Defender rotativo magnetico, Blocca aste aggiuntivo, Serratura con trappola, Sensore di allarme) che possono migliorare la sicurezza ed il livello di inaccessibilità delle nostre porte

 <p>CLASSE 4</p>	 <p>CLASSE 3</p>	 <p>CLASSE 2</p>
U T I L I Z Z O		
Consigliate per villette e appartamenti isolati con beni di lusso, uffici industriali, banche e gioiellerie.	Consigliate per uffici o edifici industriali e villette signorili con rischio medio-alto	Consigliate per appartamenti in condomini e uffici industriali con rischio medio
C A R I C O S T A T I C O		
applicazione di 10 kN (circa 1000 kg)	applicazione di 6 kN (circa 600 kg)	applicazione di 3 kN (circa 300 kg)
C A R I C O D I N A M I C O		
massa di 30 kg fatta oscillare tramite cavo d'acciaio da un'altezza di 1200 mm	massa di 30 kg fatta oscillare tramite cavo d'acciaio da un'altezza di 1200 mm	massa di 30 kg fatta oscillare tramite cavo d'acciaio da un'altezza di 800 mm
A T T A C C O M A N U A L E		
lo scassinatore esperto usa, in aggiunta agli attrezzi della classe 3, seghe, martelli pesanti, scalpelli. ecc...	lo scassinatore tenta di entrare usando, in aggiunta agli attrezzi della classe 2, un cacciavite e un piede di porco	lo scassinatore occasionale cerca di forzare la porta usando cacciaviti, pinza regolabile, tenaglie e cunei
		

TIPI DI ISOLAMENTO



ACUSTICO

Anche l'isolamento acustico degli edifici, oltre ad essere una componente fondamentale per il benessere, la salute e la privacy delle persone, è una caratteristica richiesta dal mercato immobiliare che stabilisce il grado di isolamento del rumore in funzione della destinazione dell'edificio.

In base a queste necessità, le porte blindate Stark sono costruite per garantire il maggior potere fono-isolante grazie ai materiali utilizzati per la coibentazione interna, alle guarnizioni perimetrali di battuta dell'anta, all'isolamento tra telaio e controtelaio e all'utilizzo di soglie di battuta sia fisse che mobili.

Le porte blindate Stark raggiungono alti valori di abbattimento acustico grazie all'alta capacità di isolare l'interno di un ambiente dal rumore proveniente dall'esterno.

Grande importanza per la definizione del valore hanno le modalità di posa ed installazione della porta blindata e l'insieme dei componenti che costituiscono le pareti, rendendo pertanto molto complesso stabilire il valore di abbattimento di ogni singolo componente in cantiere e non presso un laboratorio di prova specializzato.

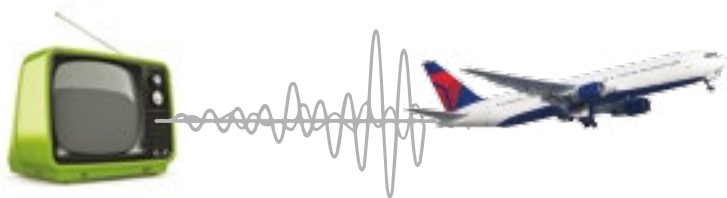

TERMICO

L'aumento delle emissioni in atmosfera dei gas che contribuiscono all'effetto serra e l'uso di fonti energetiche non rinnovabili, rendono necessari interventi per limitare l'inquinamento ed il consumo energetico, che in Italia è rappresentato per circa il 40% dal settore delle costruzioni.

L'edilizia ha pertanto un ruolo importante nella limitazione della dispersione di energia tra ambiente interno ed esterno, sia per il riscaldamento che per il condizionamento dell'edificio.

A partire dal 2006 sono inoltre in vigore norme legislative che impongono dei valori specifici di isolamento per garantire risparmio energetico. Ottimo isolamento termico dunque significa:

- Minor inquinamento atmosferico
- Maggior confort abitativo
- Riduzione dei consumi energetici
- Risparmio economico

La modalità per definire l'isolamento termico è il calcolo della trasmittanza termica degli elementi che separano interno ed esterno delle abitazioni, per cui nel nostro caso delle porte blindate esterne.



TRASMITTANZA



L'isolamento termico è la capacità della porta blindata di ridurre lo scambio termico tra l'ambiente esterno e quello interno. Questa capacità viene determinata dalla trasmittanza termica, indicata con U (si misura in W/m^2K). Il valore in tabella indica la trasmittanza della porta completa, anta e telaio nelle varie condizioni di posa e spessori dei rivestimenti. Più basso è il valore, maggiore sarà l'isolamento.

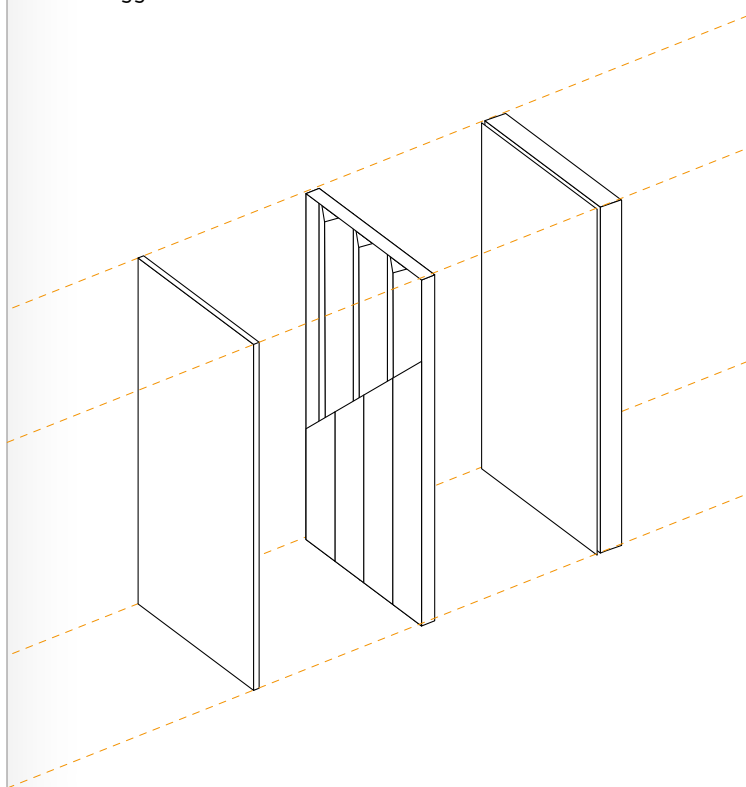

COMPOSIZIONE PORTONCINO

RIVESTIMENTO INTERNO	STRUTTURA	RIVESTIMENTO ESTERNO
6		6
		14
		14 IS3
14		6
		14
		14 IS3

TELAIO E COPERTURA

In tabella sono riportati i valori di trasmittanza per porte a singolo battente nelle varie configurazioni di spessore rivestimento e modalità di copertura del telaio. I valori indicati sono relativi a condizioni di posa accurata con muratura isolante. I valori in tabella vanno aumentati per:

Modello SR2 singolo battente = + 0,4

Versioni doppio battente = + 0,2

Versioni a vetro = + 0,2

Versioni con sopra luce = + 0,2

TELAIO NON RIVESTITO	TELAIO RIVESTITO CON PRO-FILO IN LEGNO LATO INTERNO O LATO ESTERO	TELAIO RIVESTITO DA ENTRAMBI I LATI CON PROFILI IN LEGNO
1,6	1,5	1,4
1,4	1,3	1,2
1,3	1,2	1,1
1,4	1,3	1,2
1,3	1,2	1,1
1,2	1,1	1,0

ISOLAMENTO ACUSTICO



L'isolamento acustico è la capacità di limitare la diffusione del rumore. Questa capacità viene misurata in dB ed è definita da prove specifiche realizzate in laboratorio.

Valori standard

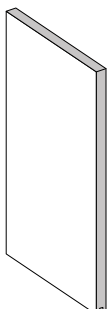
		Exclusive	Style	Project
		EH4 • EX3	SH4 • ST7 • ST10	PH4 • PR7 • PR10
		32 dB		29 dB

Valori con anta con coibentazione interna **Ecozero**

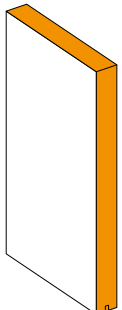
		Exclusive	Style	Project
		EH4 • EX3	SH4 • ST7 • ST10	PH4 • PR7 • PR10
		36 dB		32 dB

Valori con anta con coibentazione interna **Ecozero** + soglia tipo **E-P-W**

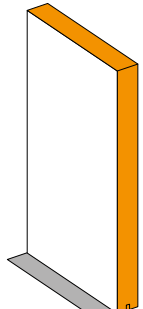
		Exclusive	Style	Project
		EH4 • EX3	SH4 • ST7 • ST10	PH4 • PR7 • PR10
		42 dB		36 dB

Ecozero

È il pannello isolante termoacustico utilizzato per i blindati Stark, ed è realizzato in PET riciclato da bottiglie, ecologico, riciclabile, stabile nel tempo e anallergico.

■ LINEA Exclusive

Sicurezza in armonia con il design

La sicurezza non necessariamente è pesante ed invadente, le porte della linea Exclusive con le soluzioni di telaio e cerniere a scomparsa si adattano perfettamente ad ogni contesto di design sia interno che esterno. Le realizzazioni filomuro e filo cornice fanno di Exclusive un componente di arredo dal design ricercato, nulla a che vedere con le porte blindate tradizionali.

Rivestimento
FIBERLINE KN11
effetto pietra



L'essenzialità delle cerniere a scomparsa

Tutti i modelli della linea Exclusive sono realizzati con cerniere a scomparsa con apertura max 115°, ridotta a 90° con profili di copertura interni. Le cerniere permettono la regolazione della porta su 2 assi facilitando la posa o future regolazioni.

Exclusive LINEA

Anche il blindato è rasomuro

Exclusive nella versione FM è perfettamente a filo parete, l'essenzialità può essere raggiunta fornendo il rivestimento interno con finitura intonacabile come la parete stessa. La complanarità dell'anta alla parete si ottiene con apposito kit di muratura del telaio.





Portoncino lato esterno
con due fianchi luce fissi.

Rivestimento STONE PT11

Particolare fissaggio
rivestimento interno da 6 mm

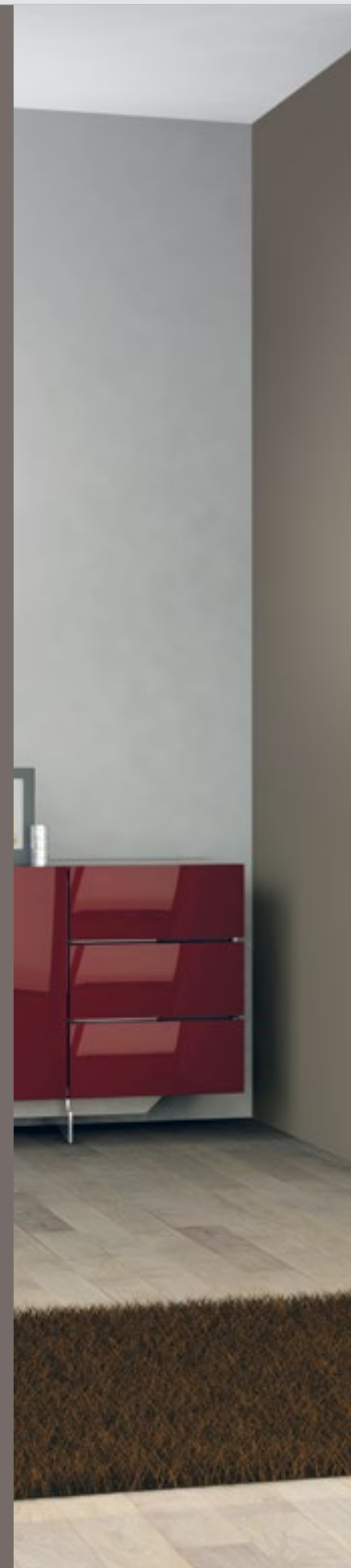



LINEA Exclusive

Soluzione anta FM con posa telaio a filo cornice. L'anta rimane complanare con profili di rifinitura sp=14 mm realizzabili nella stessa finitura del rivestimento.

Rivestimento CHROME FF4

Particolare fissaggio rivestimento interno da 14 mm versione FM



MODELLO
EH4
 EXCLUSIVE



1,6 ÷ 1,0 W/m²k



32 ÷ 42 db



CLASSE 4

Serratura e punti
 di chiusura mobili
 con ganasce

ERACLE



ERACLE/DS



ERACLE/FL



Struttura tripla lamiera **1**

Realizzata a 3 livelli di lamiera con rinforzi perimetrali e piastra di protezione serratura a tutta altezza

Isolamento interno **2**

Coibentazione interna con doppio strato di isolamento in polistirene espanso + ecotex (materiale isolante realizzato con fibre tessili)

Rostri fissi antistrappo **3**

4 punti di chiusura fissi antistrappo sul lato cerniere, si inseriscono nel telaio a porta chiusa

Registro scrocco regolabile **4**

Garantisce la perfetta chiusura anche in caso di dilatazioni termiche

Defender conico **5**

Protezione cilindro a forma conica che limita il tentativo di strappo o estrazione

Carenature in vari colori **6**

Carenature in lamiera zincata plastificata con finitura effetto inox di serie, disponibili a richiesta in finitura bianco o ral a richiesta

Cerniere a scomparsa **7**

Cerniere invisibili a porta chiusa regolabili su 2 assi, apertura max 115°

Soglia sfilabile **8**

Soglia sfilabile ad alto isolamento con sistema di estrazione lato serratura

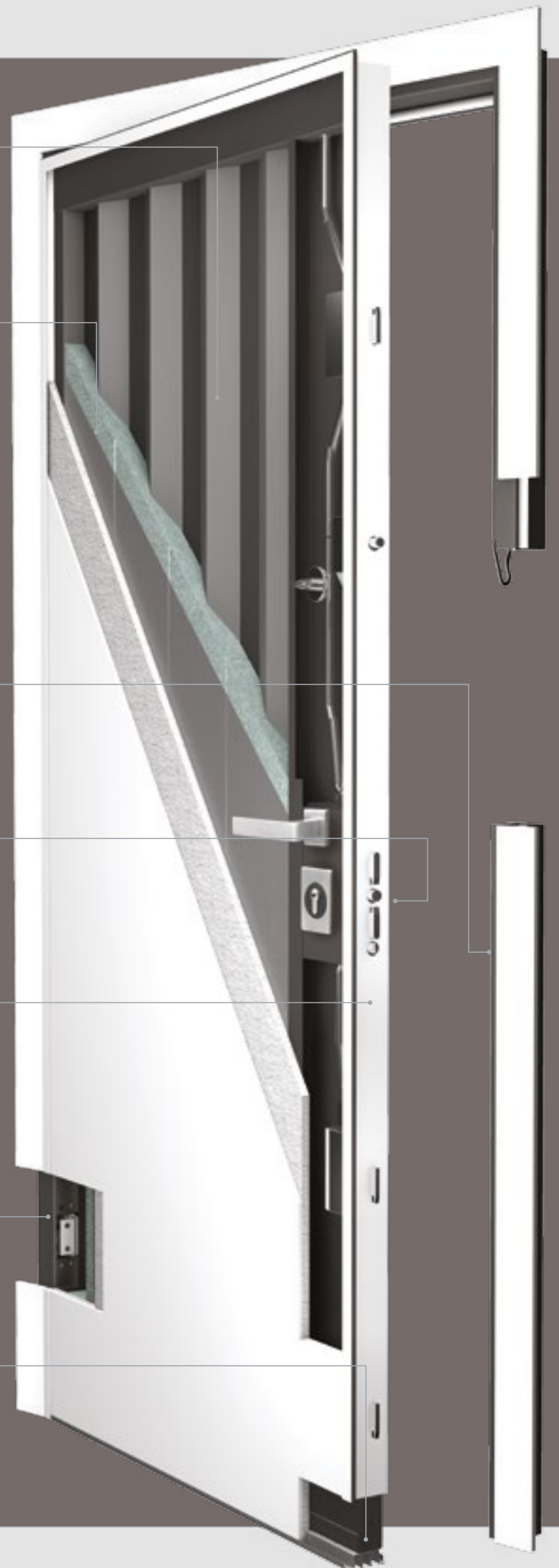

MODELLO
EX3
 EXCLUSIVE



CLASSE 3



1,6 ± 1,0 W/m²K



32 ÷ 42 db

Particolari che si differenziano dal modello **EH4**

Struttura doppia lamiera **1**

Struttura doppia lamiera realizzata a 2 livelli di lamiera con piastra di protezione serratura

Isolamento interno **2**

Coibentazione interna con doppio strato di isolamento in polistirene espanso

Rostri fissi **3**

4 punti di chiusura fissi sul lato cerniere, si inseriscono nel telaio a porta chiusa

Serratura e punti di chiusura mobile

NETTUNO



SATURNO



PLUTONE



ARGO



MARTE



ZEUS



SMART

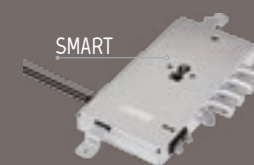

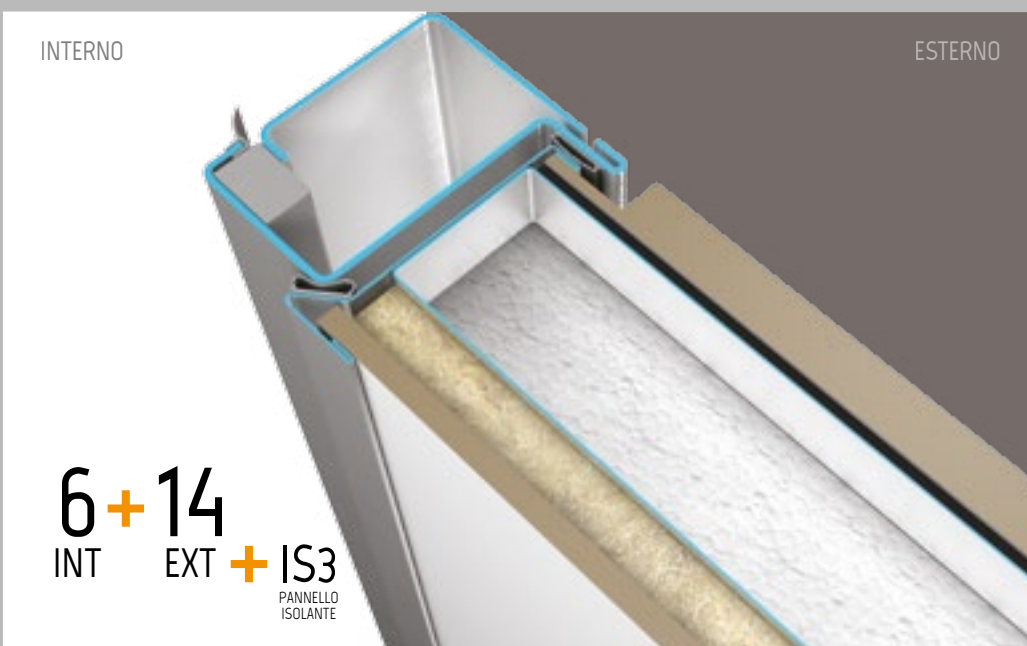
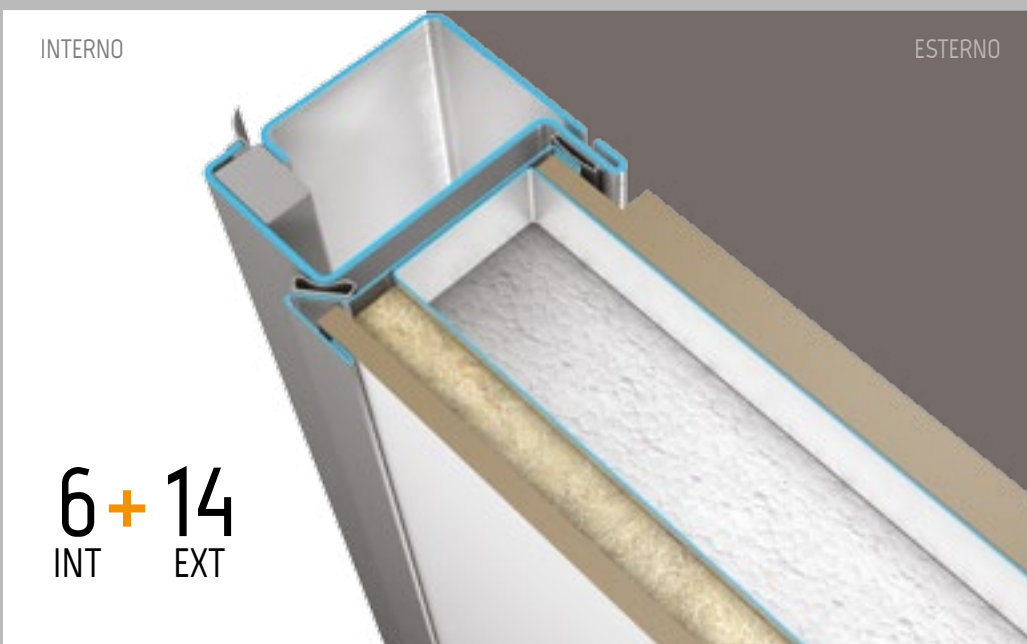
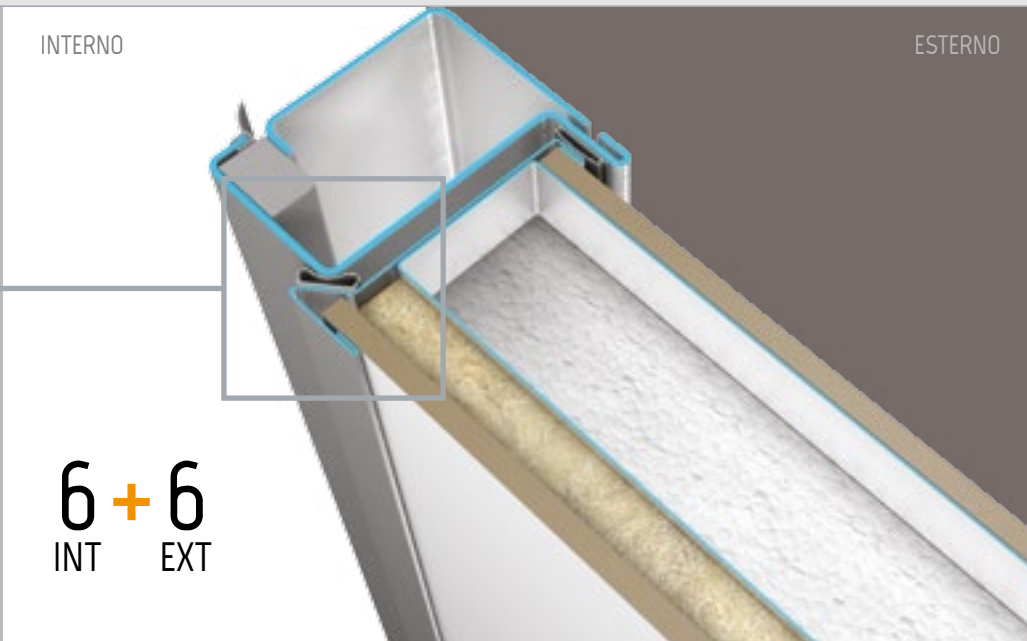

SEZIONE PANNELLI

Exclusive

Configurazione di montaggio dei rivestimenti interni ed esterni più eventuali pannelli isolanti IS3 inserito sul lato esterno. Carenature di fissaggio rivestimenti in lamiera zincata plastificata con finitura effetto inox di serie, disponibili a richiesta in finitura bianco o ral a richiesta

INTERNO

ESTERNO

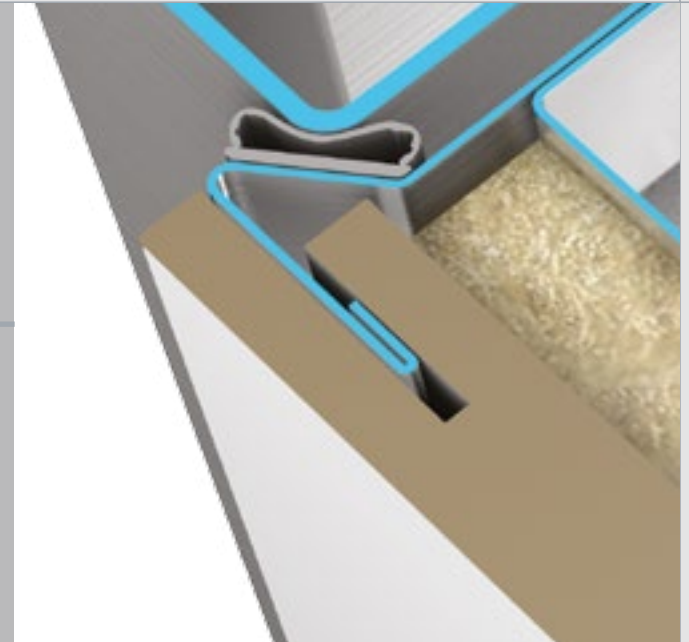
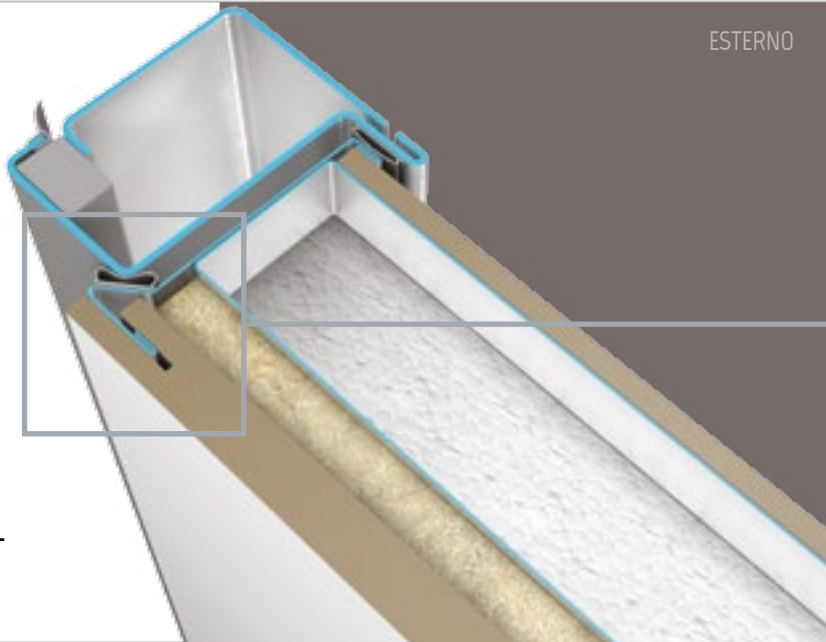

14+6
INT EXT

INTERNO

ESTERNO

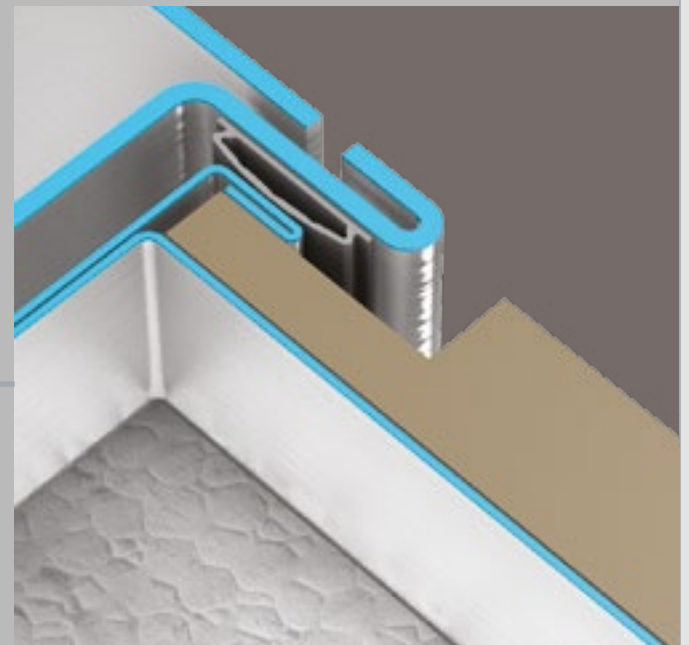
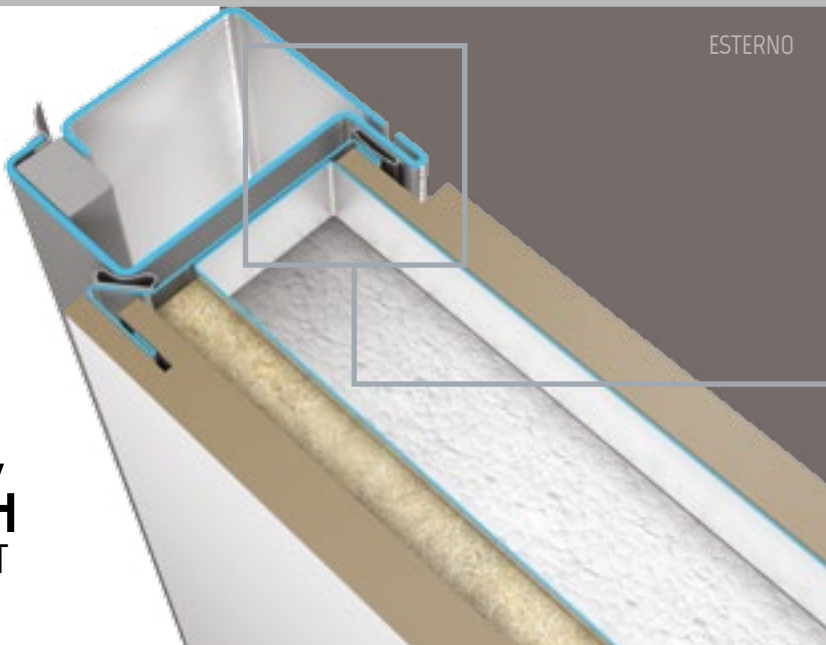

14+14
INT EXT

INTERNO

ESTERNO

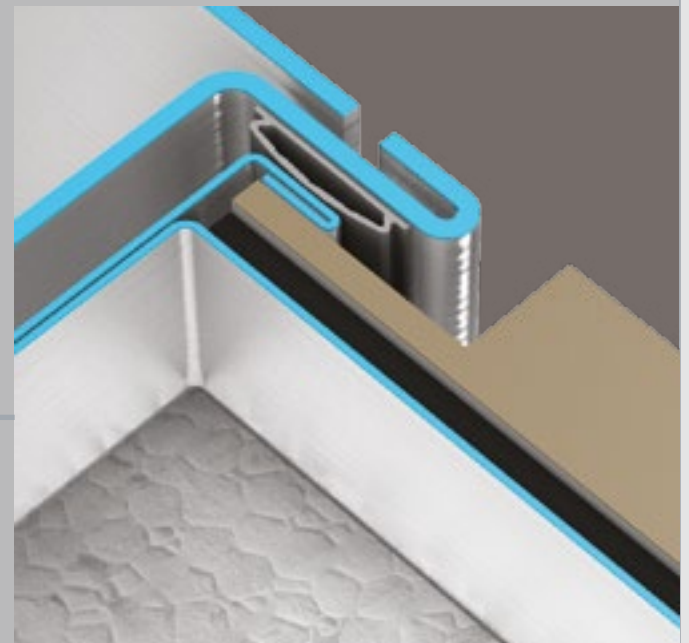
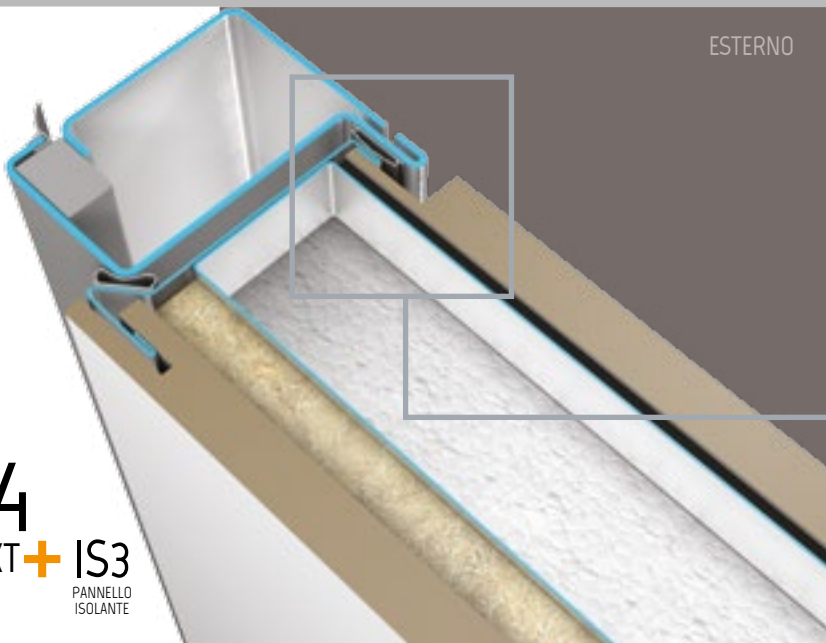

14+14
INT EXT + IS3
PANNELLO ISOLANTE

SOLUZIONI DI POSA EXCLUSIVE CON ANTA STANDARD

Soluzioni lato interno

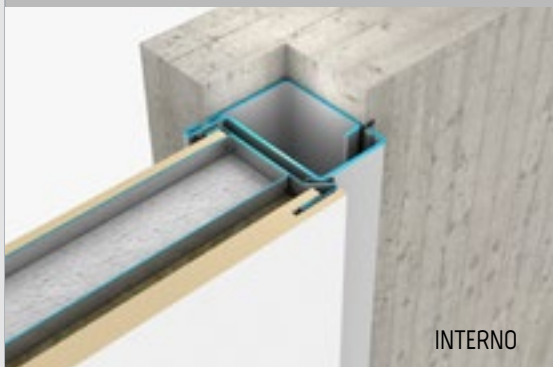

1 Soluzione standard senza profili di copertura telaio (Controtelaio posa standard)

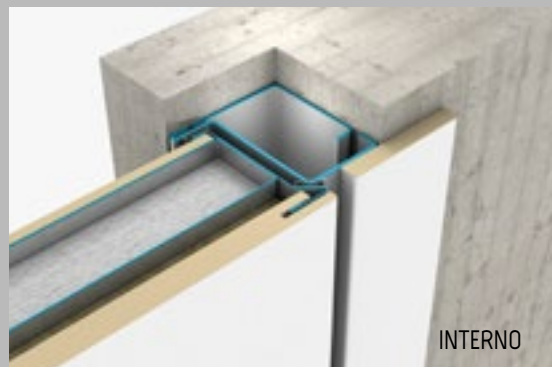

2 Soluzione telaio filomuro con coprifilo piatto per copertura interna (Kit posa controtelaio FI)

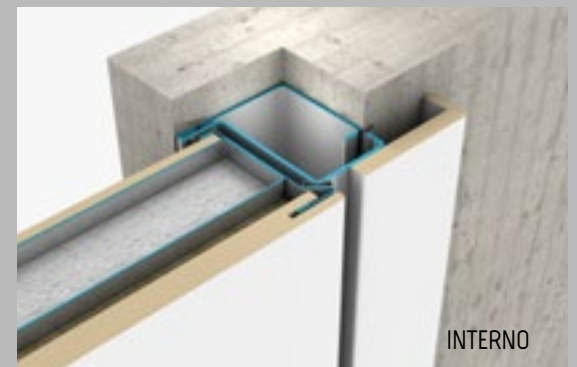

3 Soluzione standard con coprifilo con aletta per copertura interna

Soluzioni lato esterno

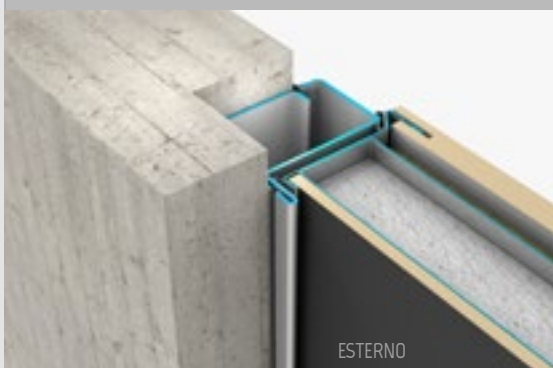

4 Soluzione standard senza profili di copertura telaio lato esterno

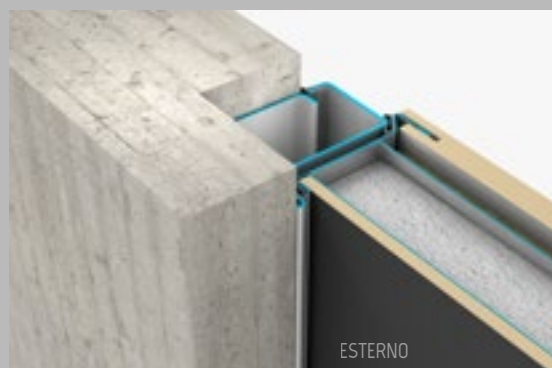

5 Soluzione filomuro esterno senza profili di copertura telaio (Kit posa controtelaio FE)

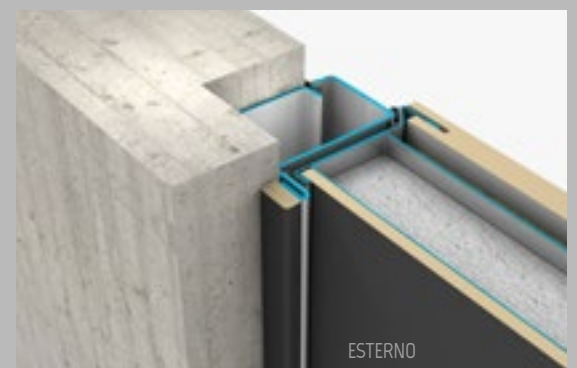

6 Soluzione standard con profili di copertura telaio lato esterno

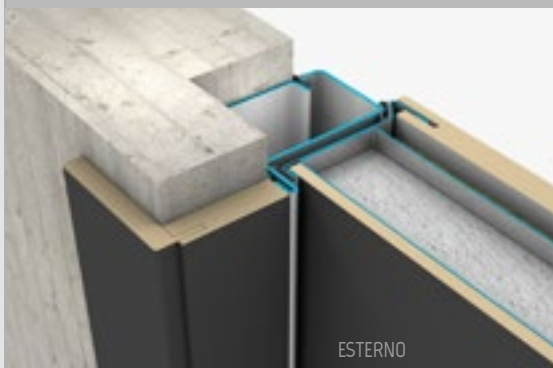

7 Soluzione telaio con passata (imbotte) in legno lato esterno

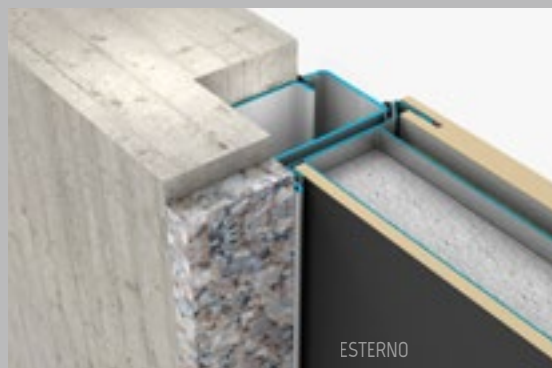

8 Soluzione telaio con marmo o pietra esistente lato esterno

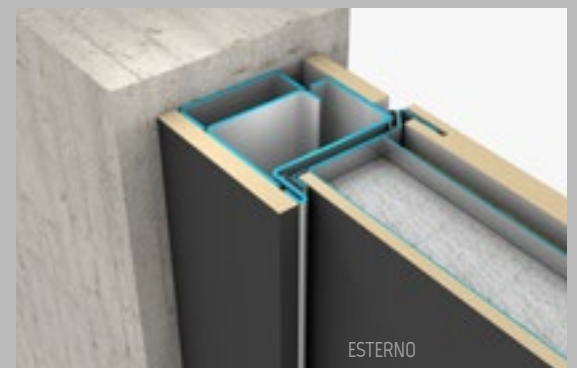

9 Soluzione posa telaio centro muratura con profili di copertura telaio interni ed esterni (posa controtelaio con profilo di compensazione saldato sul telaio)

SOLUZIONI DI POSA EXCLUSIVE CON ANTA FM COMPLANARE

Soluzione anta **raso cornice**

A Soluzione telaio filo muro interno ed esterno. Anta FM complanare con cornice di rifinitura sp=14mm disponibile nella stessa finitura del rivestimento

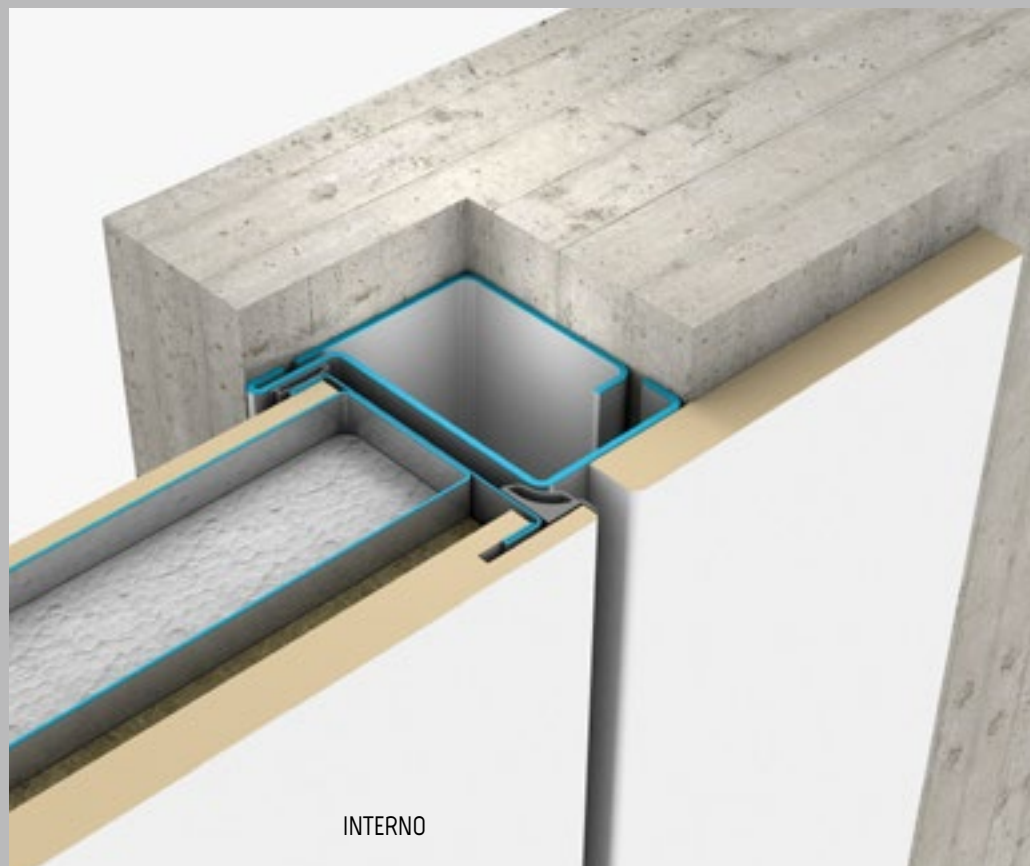
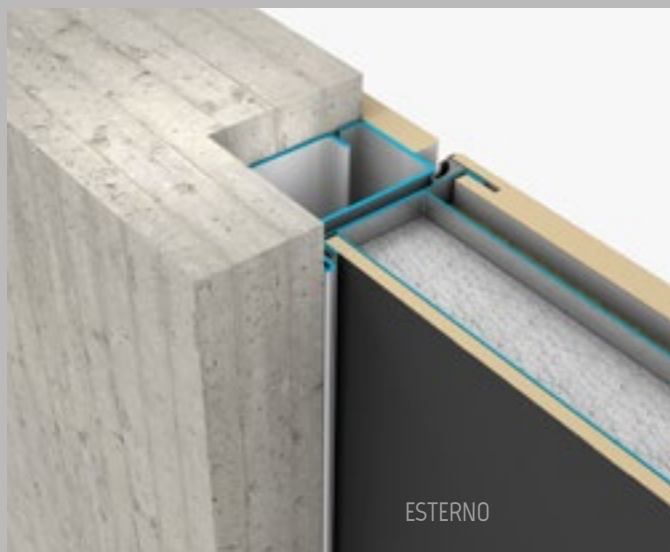

Soluzione anta **raso muro**

B Soluzione anta FM filomuro esterno ed interno per muratura o cartongesso.

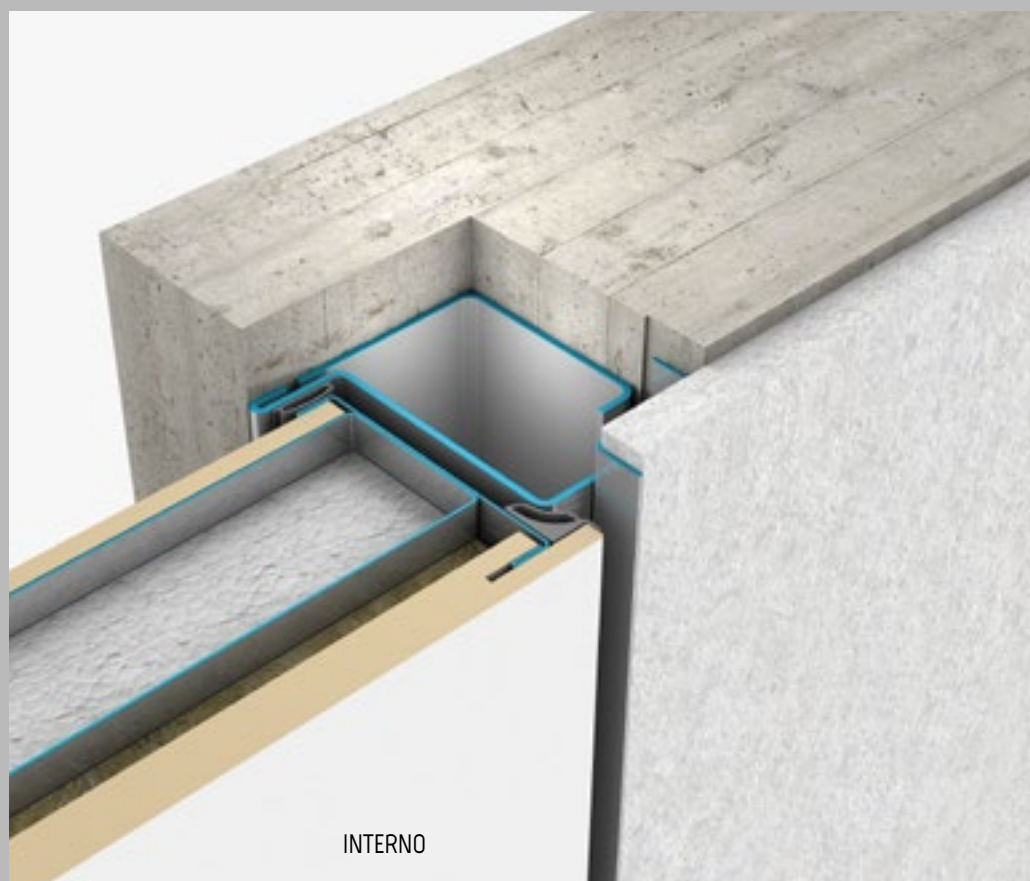
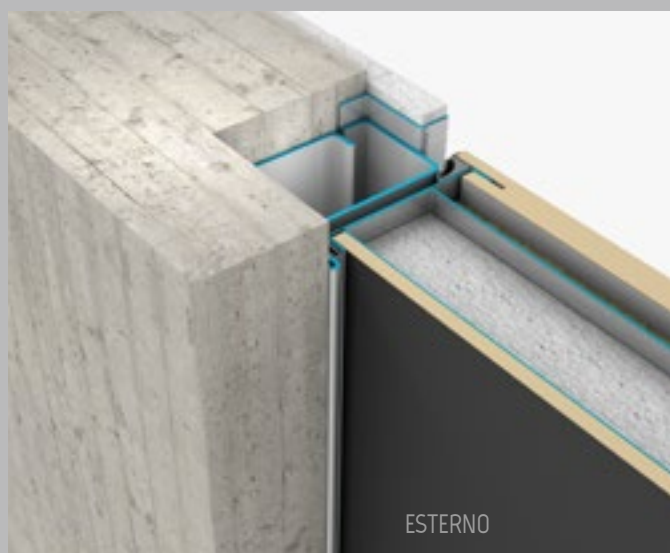

LINEA Style

Il miglior compromesso tra
sicurezza, stile e duttilità di utilizzo

Le porte Style offrono ampie soluzioni di posa per adattarsi alle nuove costruzioni come ai casi più complessi di ristrutturazione. Il rivestimento interno fissato con angolari in legno riveste completamente la struttura in acciaio e facilita la sostituzione o interventi di manutenzione anche in caso di porta chiusa.



Rivestimento
RUSTICI T5



Rivestimento
CROSS V19



Particolare dell'angolare di fissaggio
per rivestimento interno da 6 mm



Rivestimento
CHROME F155

LINEA
Style

Il blindato attento ai particolari

Nella linea Style il fissaggio dei rivestimenti è indipendente tra lato interno ed esterno, la struttura dell'anta sul lato interno è completamente rivestita in legno garantendo la massima cura dei particolari.



Rivestimento
LAMINATE LMO
Quercia terra

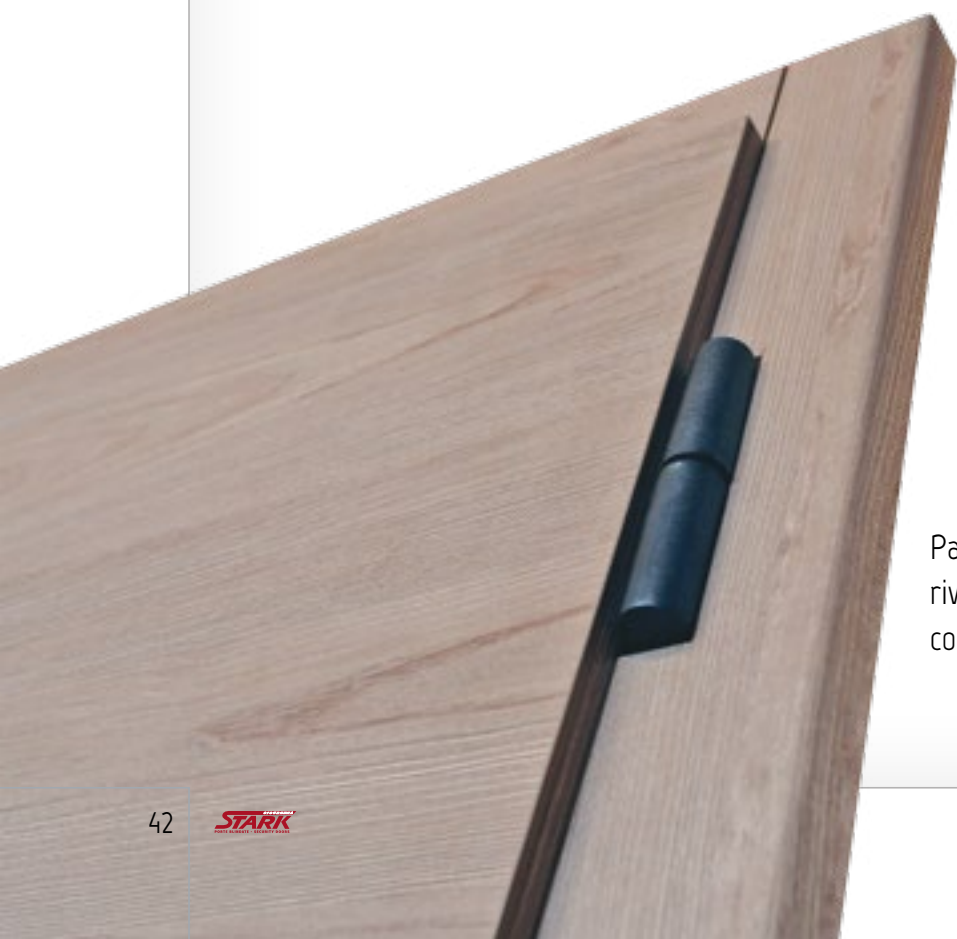

Particolare fissaggio
rivestimento interno da 14 mm
con profili di copertura telaio.





Rivestimento
LAMINATE LMO - Quercia perla



LINEA
Style



MODELLO
SH4
 STYLE



1,6 ÷ 1,0 W/m²K



32 ÷ 42 db



CLASSE 4

Serratura e punti
 di chiusura mobili
 con ganasce

ERACLE

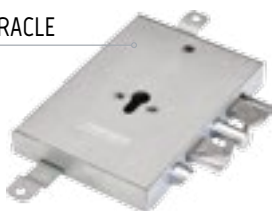

ERACLE/DS



ERACLE/FL



Struttura tripla lamiera 1

Realizzata a 3 livelli di lamiera con rinforzi perimetrali e piastra di protezione serratura a tutta altezza

Isolamento interno 2

Coibentazione interna con doppio strato di isolamento in polistirene espanso + ecotén (materiale isolante realizzato con fibre tessili)

Rostri fissi antistrappo 3

4 punti di chiusura fissi antistrappo sul lato cerniere, si inseriscono nel telaio a porta chiusa

Registro scrocco regolabile

Garantisce la perfetta chiusura anche in caso di dilatazioni termiche

Defender conico 4

Protezione cilindro a forma conica che limita il tentativo di strappo o estrazione

Carenature in vari colori 5

Carenature in lamiera zincata plastificata con finitura effetto inox di serie, disponibili a richiesta in finitura bianco o ral a richiesta. con angolare di fissaggio su rivestimento interno

Cerniere standard 6

Cerniere esterne con perno in acciaio a sfera, registrabili su 2 assi

Soglia sfilabile 7

Soglia sfilabile ad alto isolamento con sistema di estrazione lato serratura

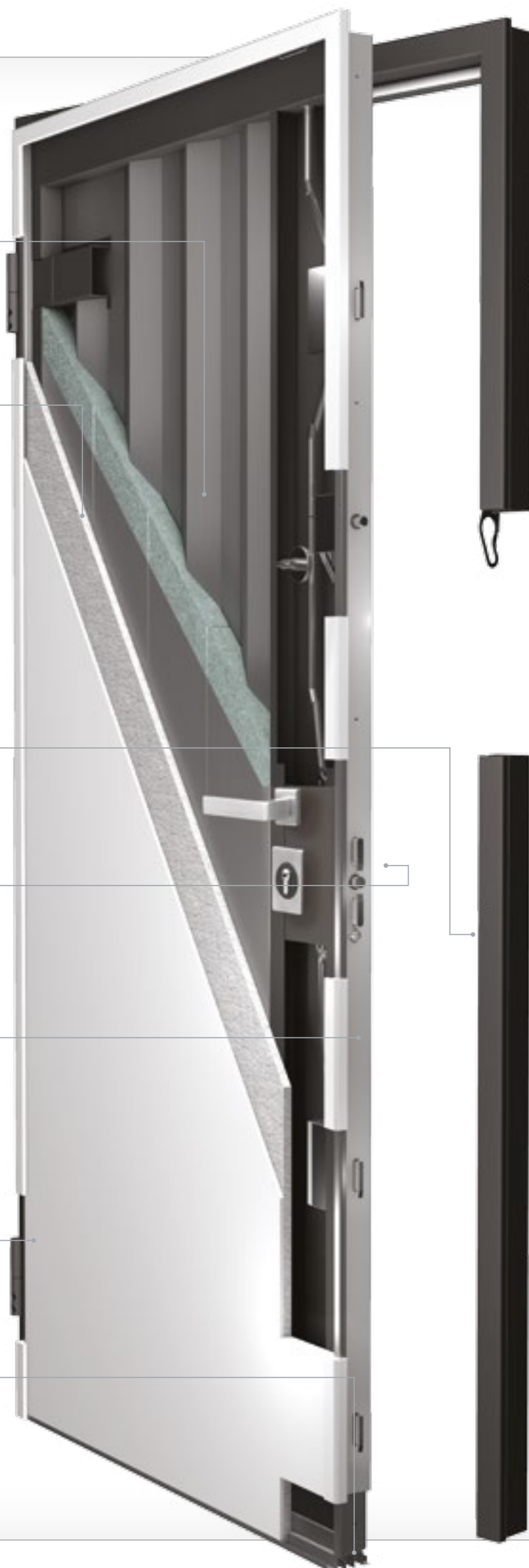

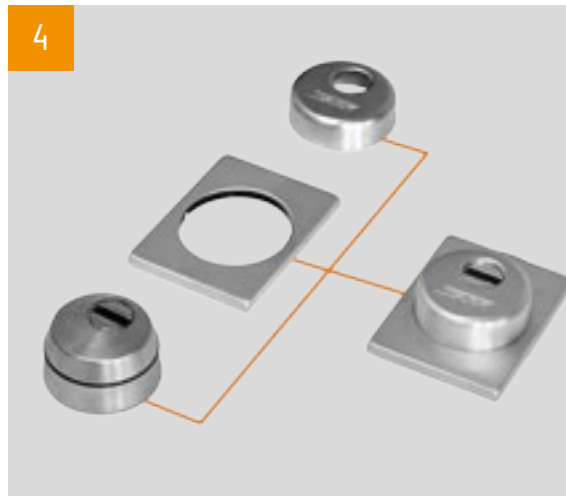

MODELLO
ST7
STYLE



1,6 ÷ 1,0 W/m²K



32 ÷ 42 db



CLASSE 3

Serratura e punti
di chiusura mobili

NETTUNO



SATURNO



PLUTONE



ZEUS



SMART



Struttura doppia lamiera **1**

Struttura doppia lamiera realizzata a 2 livelli di lamiera con piastra di protezione serratura

Isolamento interno **2**

Coibentazione interna con doppio strato di isolamento in polistirene espanso

Rostrì fissi antistrappo **3**

4 punti di chiusura fissi sul lato cerniere, si inseriscono nel telaio a porta chiusa

Registro scrocco regolabile

Garantisce la perfetta chiusura anche in caso di dilatazioni termiche (escluse serrature Zeus e Smart)

Defender conico **4**

Protezione cilindro a forma conica che limita il tentativo di strappo o estrazione

Carenature in lamiera zincata **5**

Plasticata con finitura effetto inox di serie, disponibili a richiesta in finitura bianco o ral a richiesta. con angolare di fissaggio su rivestimento interno

Cerniere standard **6**

Cerniere esterne con perno in acciaio a sfera, registrabili su 2 assi

Soglia sfilabile **7**

Soglia sfilabile ad alto isolamento con sistema di estrazione lato serratura





MODELLO
ST10
STYLE



1,6 ÷ 1,0 W/m²k



32 ÷ 42 db



CLASSE 3



Serratura e punti di chiusura mobili

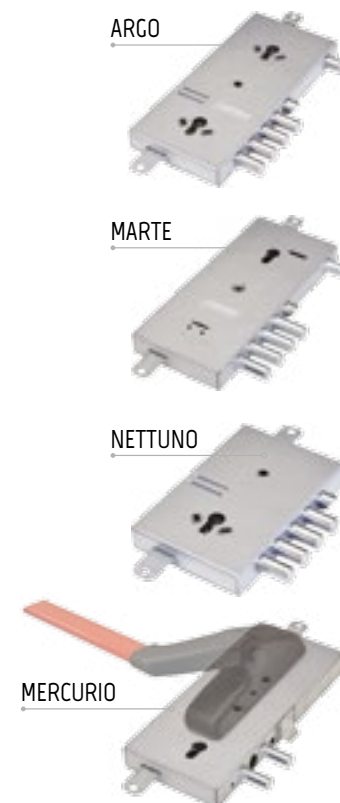

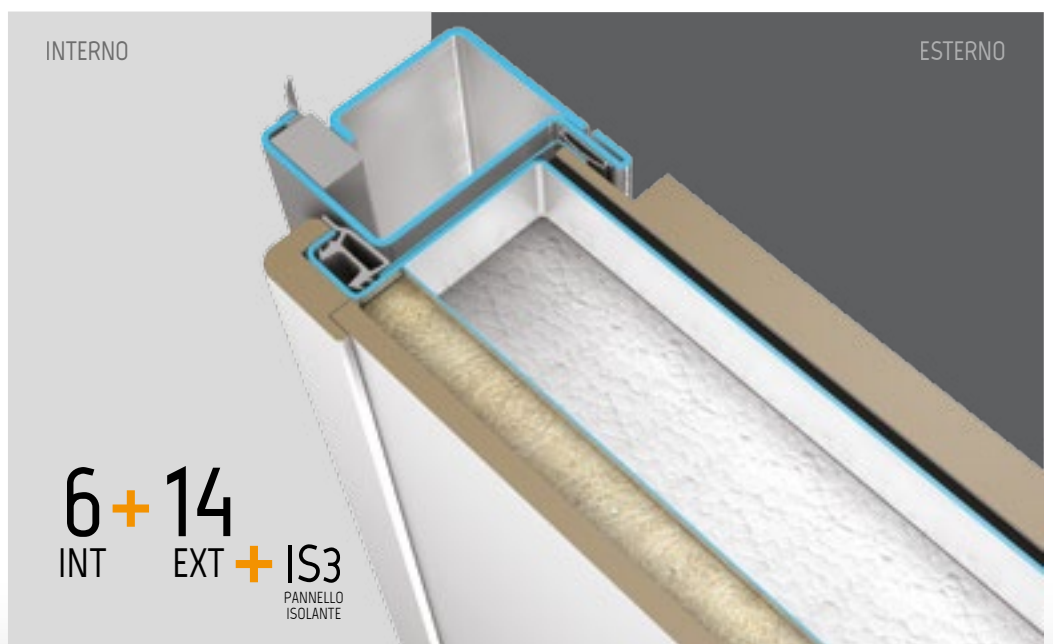
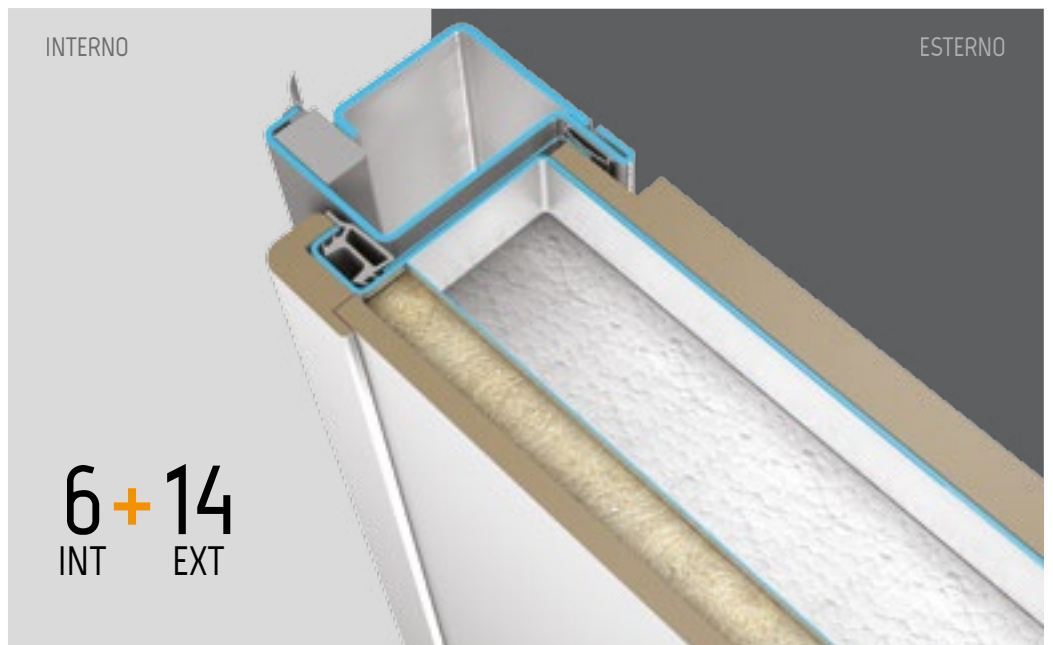
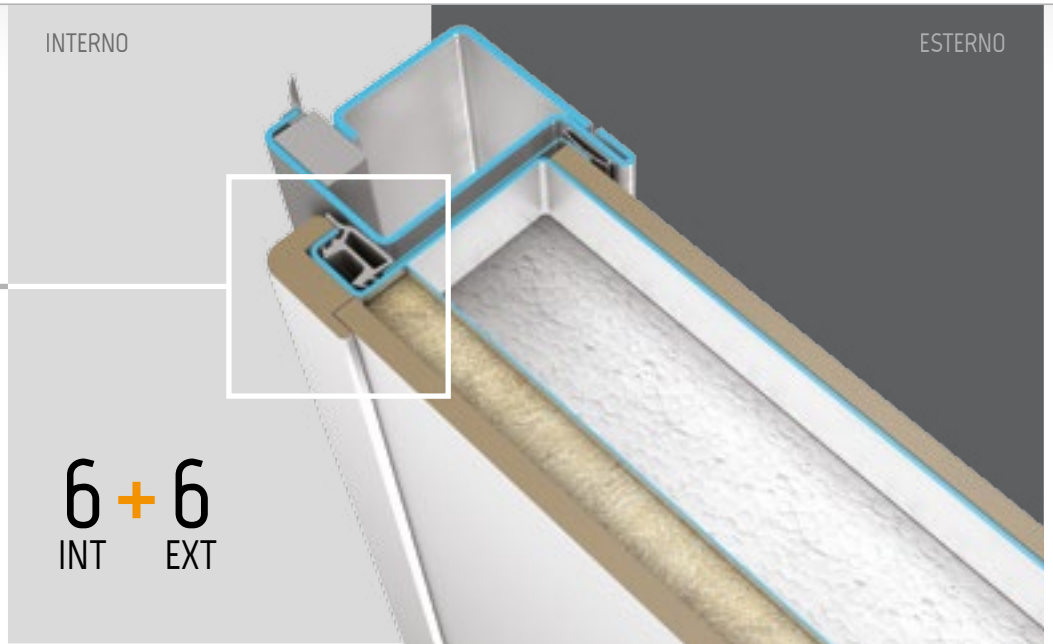
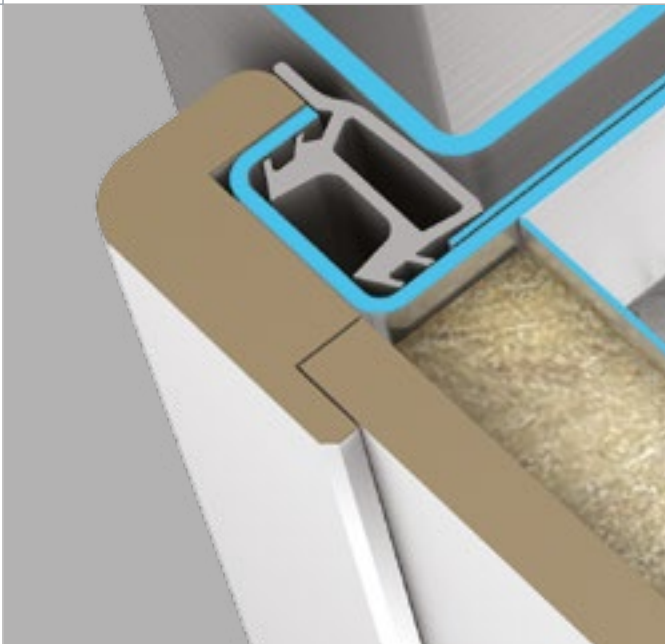

SEZIONE PANNELLI

Style

Configurazione di montaggio dei rivestimenti interni ed esterni più eventuali pannelli isolanti IS3 inserito sul lato esterno. Carenature di fissaggio rivestimenti esterni in lamiera zincata plastificata con finitura effetto inox di serie (bianco e RAL a richiesta) e fissaggio interno con angolari in legno in rilievo su rivestimenti da 6 mm, a scomparsa su rivestimenti da 14 mm

INTERNO

ESTERNO

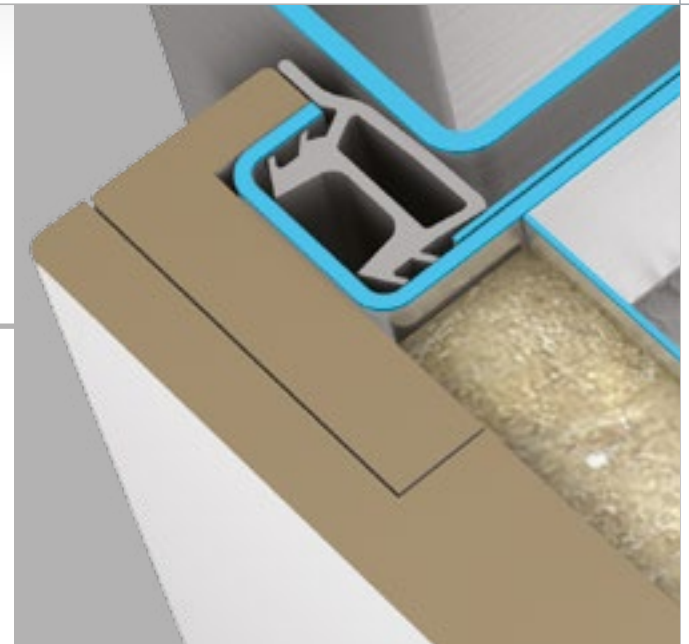
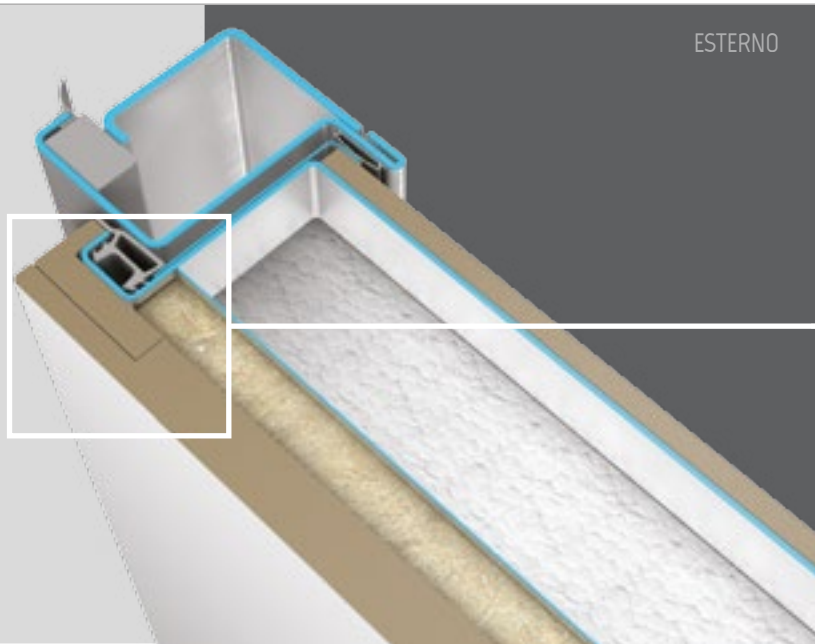

14 + 6
INT EXT

INTERNO

ESTERNO

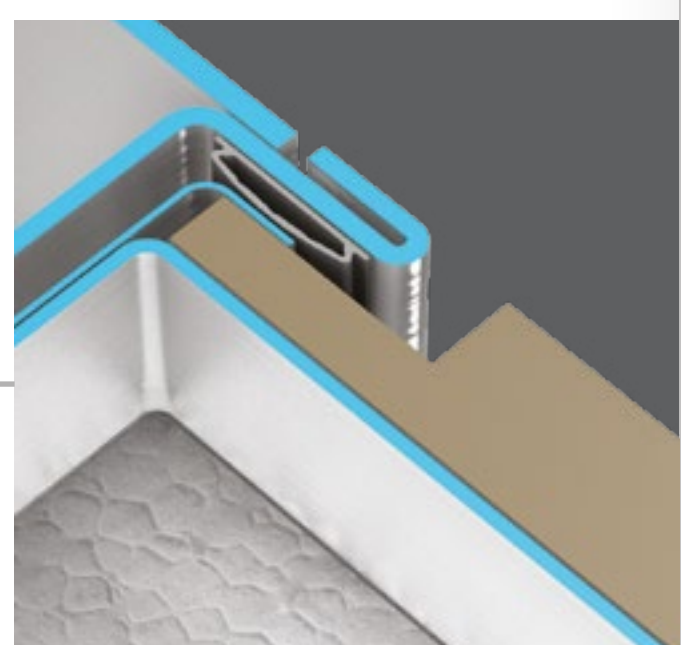
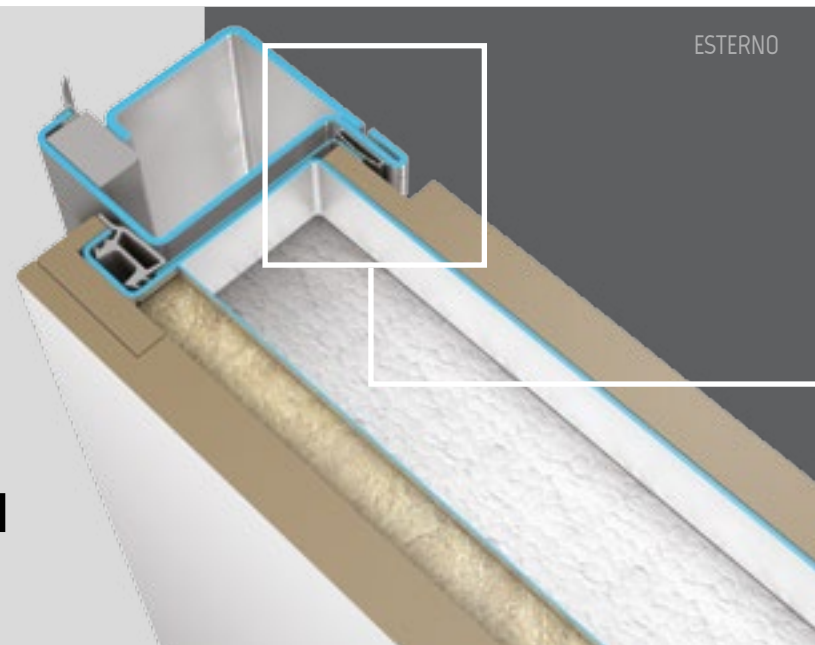

14 + 14
INT EXT

INTERNO

ESTERNO

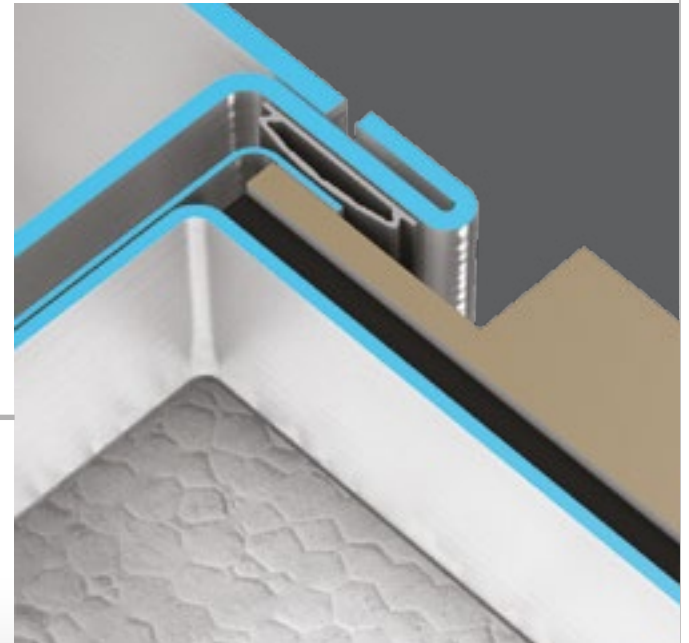
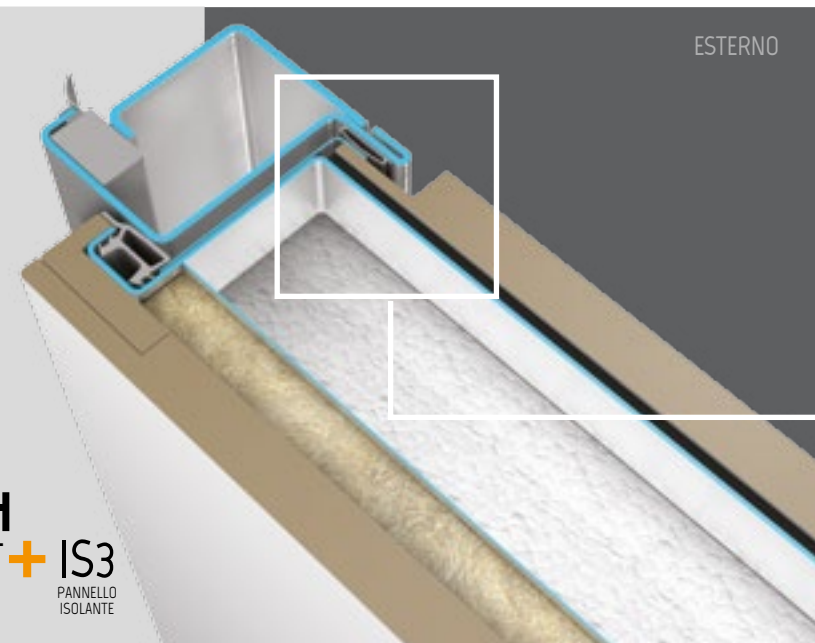

14 + 14
INT EXT + IS3
PANNELLO ISOLANTE

■ LINEA Project

Molteplici soluzioni, stessa sicurezza!

Le porte Project offrono la massima semplicità di posa e utilizzo mantenendo la versatilità tipica delle porte Stark: Scelta del design con una gamma infinita di rivestimenti, personalizzazione del sistema di sicurezza sulle più svariate esigenze ed il confort garantito dalle ottime prestazioni di isolamento termico e acustico



Rivestimento
TECHLINE Z308



Rivestimento SURFACE HPL-A effetto pietra





Rivestimento CROSS V16

LINEA Project

Anche la carenatura prende vita

Nella linea Project le carenature dell'anta sono personalizzabili con la possibilità di abbinamento con la finitura del telaio e dei rivestimenti. Di serie in finitura inox. RAL a richiesta.

Carenatura bianca



Carenatura finitura inox

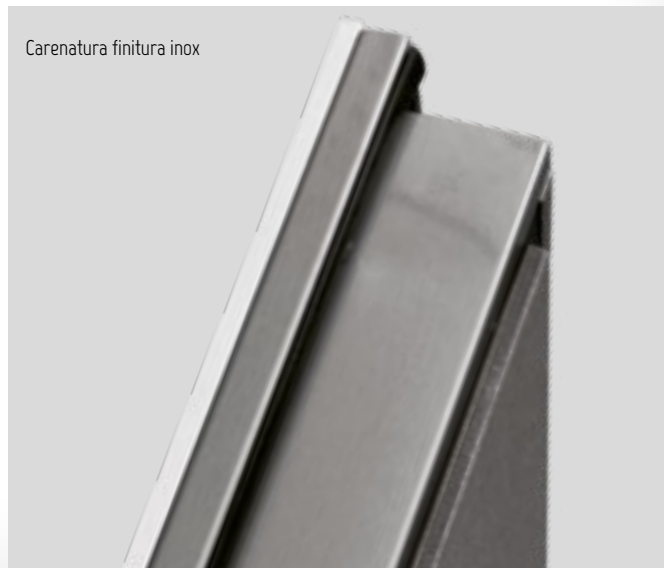



Rivestimento
EASY LS laccato bianco

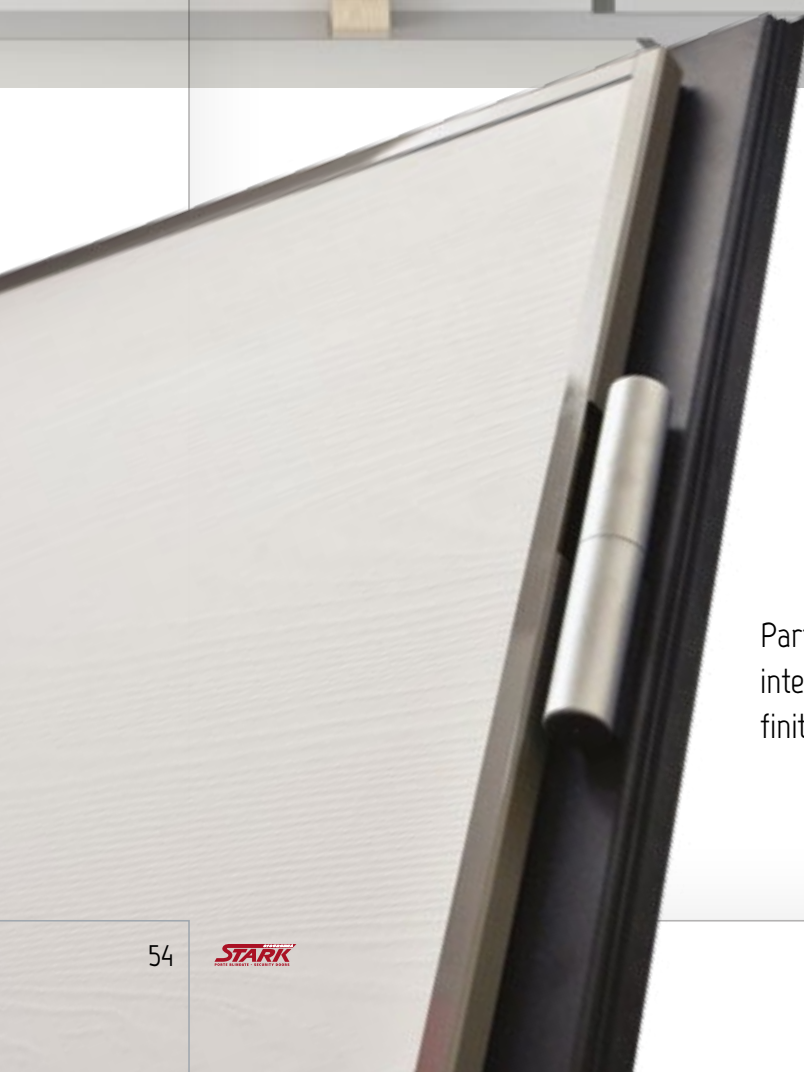

Particolare fissaggio rivestimento
interno da 6 mm con carenatura in
finitura inox. RAL a richiesta.

LINEA Project





Rivestimento
CORNER RO laccato bianco

Particolare fissaggio
rivestimento interno
da 14 mm totalmente a
scomparsa in grado di
offrire la complanarità
in facciata



MODELLO
PH4
 PROJECT



1,6 ÷ 1,0 W/m²K



32 ÷ 42 db



CLASSE 4

Serratura e punti
 di chiusura mobili
 con ganasce

ERACLE



ERACLE/DS



ERACLE/FL



Struttura tripla lamiera 1

Realizzata a 3 livelli di lamiera con rinforzi perimetrali e piastra di protezione serratura a tutta altezza

Isolamento interno 2

Coibentazione interna con doppio strato di isolamento in polistirene espanso + ecoten (materiale isolante realizzato con fibre tessili)

Rostri fissi antistrappo 3

4 punti di chiusura fissi antistrappo sul lato cerniere, si inseriscono nel telaio a porta chiusa

Registro scrocco regolabile

Garantisce la perfetta chiusura anche in caso di dilatazioni termiche

Defender conico 4

Protezione cilindro a forma conica che limita il tentativo di strappo o estrazione

Carenature in vari colori 5

Carenature in lamiera zincata plastificata con finitura effetto inox di serie, disponibili a richiesta in finitura bianco o ral a richiesta.

Cerniere standard 6

Cerniere esterne con perno in acciaio a sfera, registrabili su 2 assi

Soglia sfilabile 7

Soglia sfilabile ad alto isolamento con sistema di estrazione lato serratura



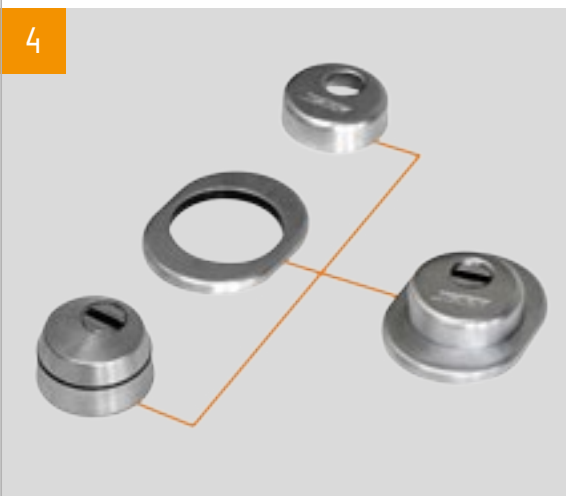
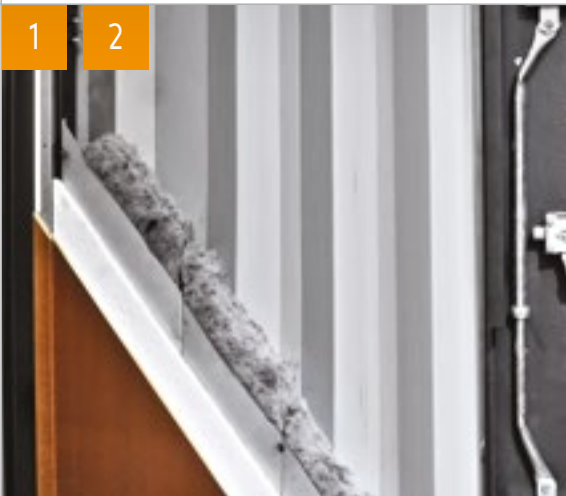

MODELLO PR7 PROJECT



1,6 ÷ 1,0 W/m²K



32 ÷ 42 db



CLASSE 3

Serratura e punti di chiusura mobili

NETTUNO



SATURNO



PLUTONE



ZEUS



SMART



Struttura doppia lamiera **1**

Realizzata a 2 livelli di lamiera con piastra di protezione serratura

Isolamento interno **2**

Coibentazione interna con doppio strato di isolamento in polistirene espanso

Rostri fissi antistrappo **3**

4 punti di chiusura fissi sul lato cerniere, si inseriscono nel telaio a porta chiusa

Registro scrocco regolabile

Garantisce la perfetta chiusura anche in caso di dilatazioni termiche (escluse serrature Zeus e Smart)

Defender conico **4**

Protezione cilindro a forma conica che limita il tentativo di strappo o estrazione

Carenature in lamiera zincata **5**

Plasticata con finitura effetto inox di serie, disponibili a richiesta in finitura bianco o RAL a richiesta con angolare di fissaggio su rivestimento interno

Cerniere standard **6**

Cerniere esterne con perno in acciaio a sfera, registrabili su 2 assi

Soglia sfilabile **7**

Soglia sfilabile ad alto isolamento con sistema di estrazione lato serratura





MODELLO
PR10
PROJECT



1,6 ± 1,0 W/m²k



32 ± 42 db



CLASSE 3



Serratura e punti
di chiusura mobili

ARCO



MARTE



NETTUNO



Rivestimento
CORNER R2



Particolare serratura

MODELLO SR2 PROJECT



2,0 ± 1,4 W/m²k



29 ± 36 db



CLASSE 2

Porte realizzabili solo in misure standard, ma con la possibilità di scegliere qualsiasi tipo di rivestimento



1

2

Struttura doppia lamiera ¹

Realizzata a 2 livelli di lamiera con piastra di protezione serratura

Isolamento interno ²

Coibentazione interna con doppio strato di isolamento in polistirene espanso

Serratura e punti di chiusura mobile

ADE



SATURNO



Rostri fissi



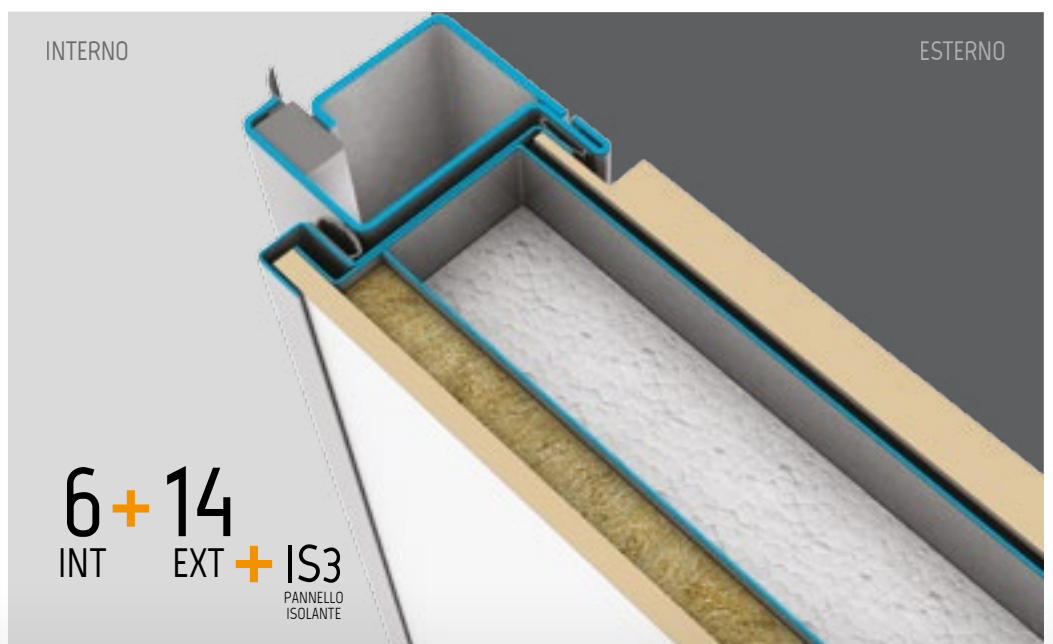
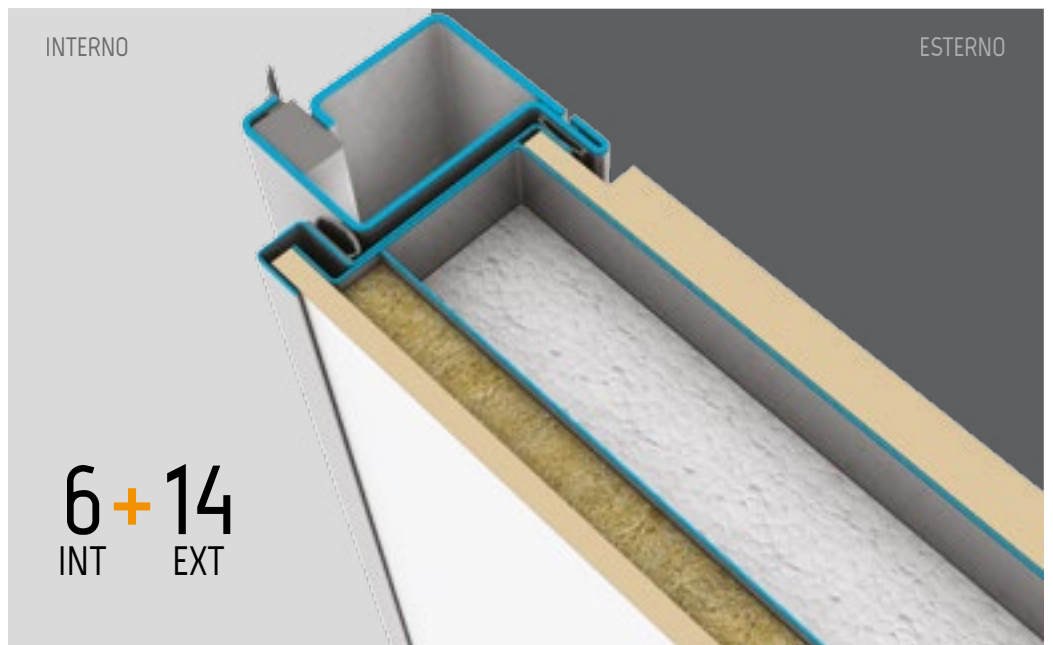
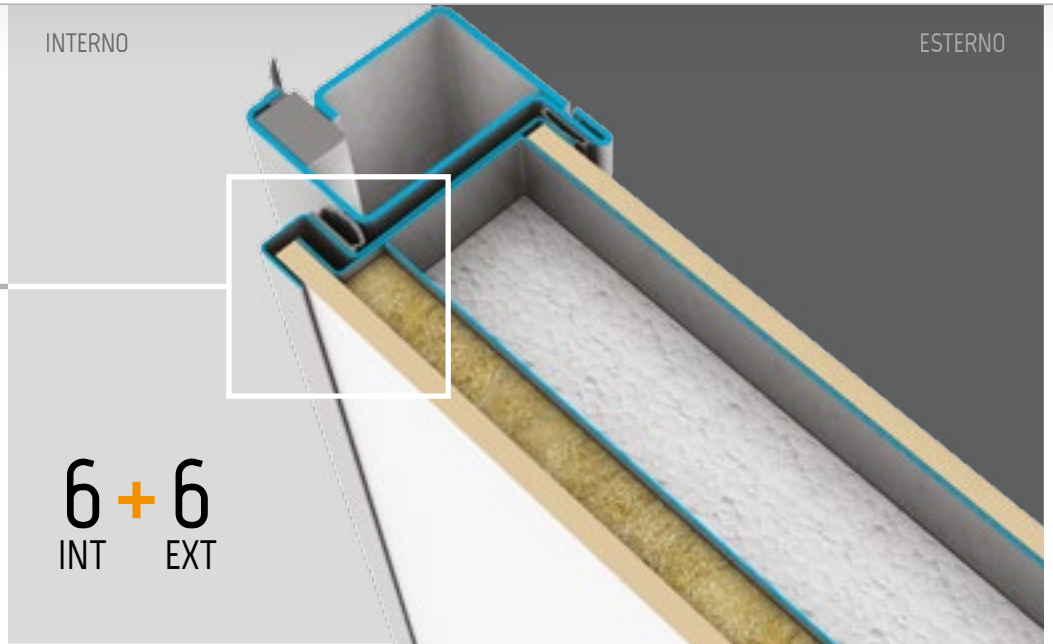

SEZIONE PANNELLI

Project

Configurazione di montaggio dei rivestimenti interni ed esterni più eventuali pannelli isolanti IS3 inseriti sul lato esterno. Carenature di fissaggio rivestimenti in lamiera zincata plastificata con finitura effetto inox di serie, disponibili a richiesta in finitura bianco o RAL a richiesta

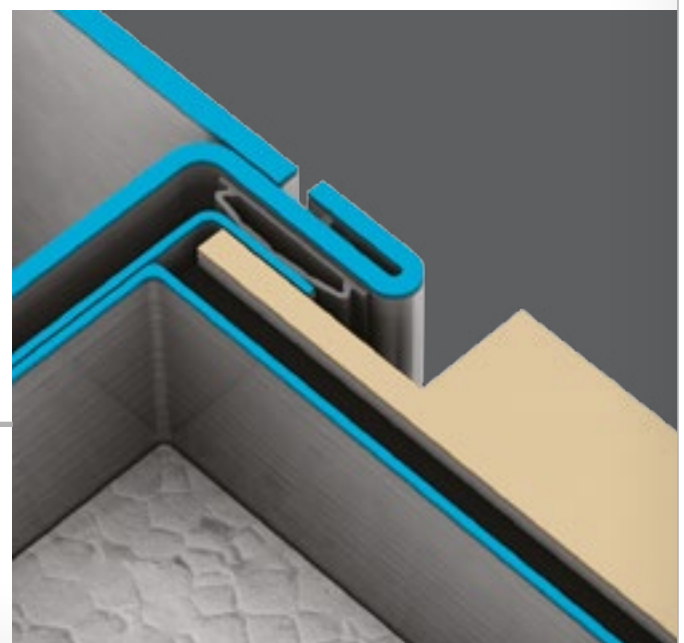
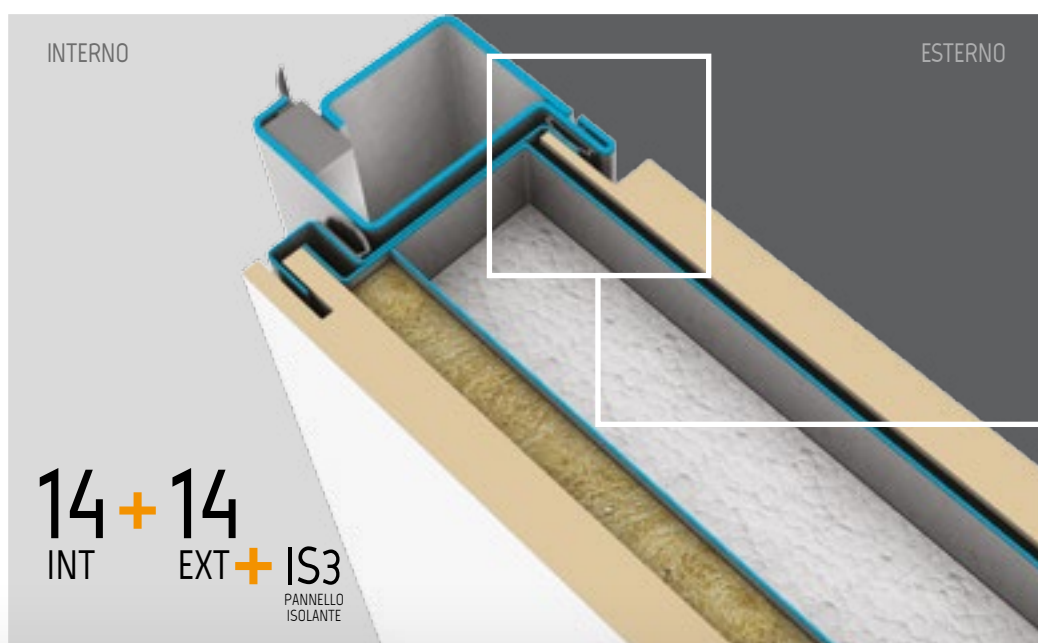
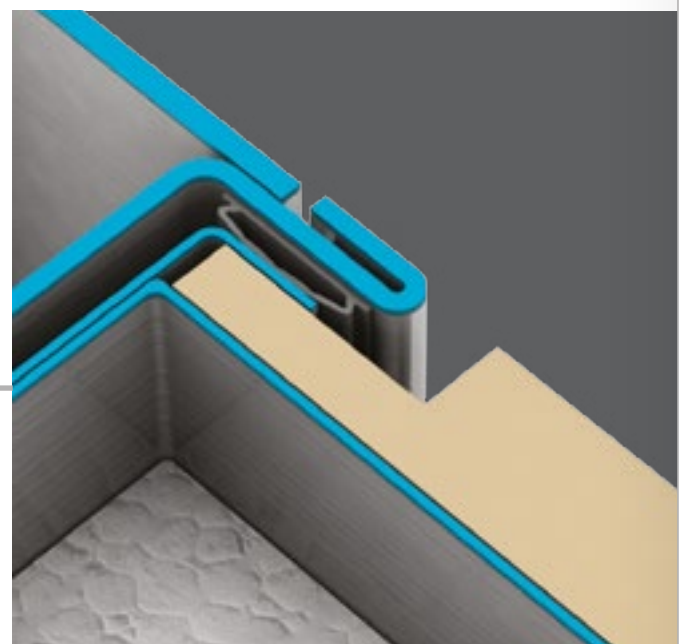
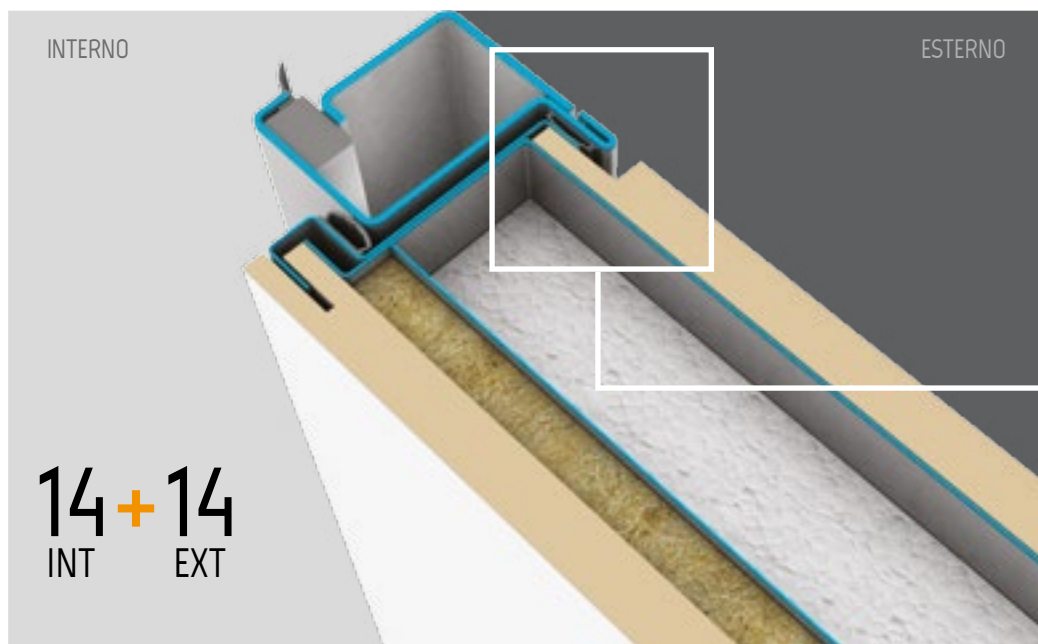
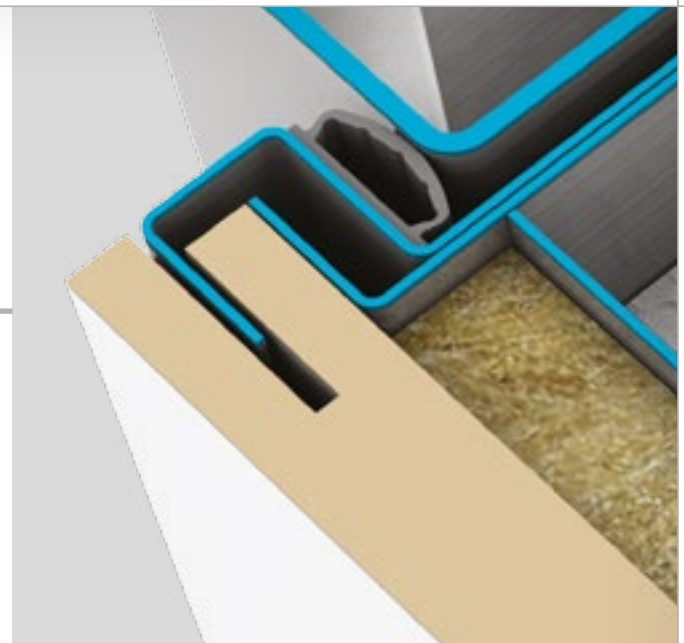
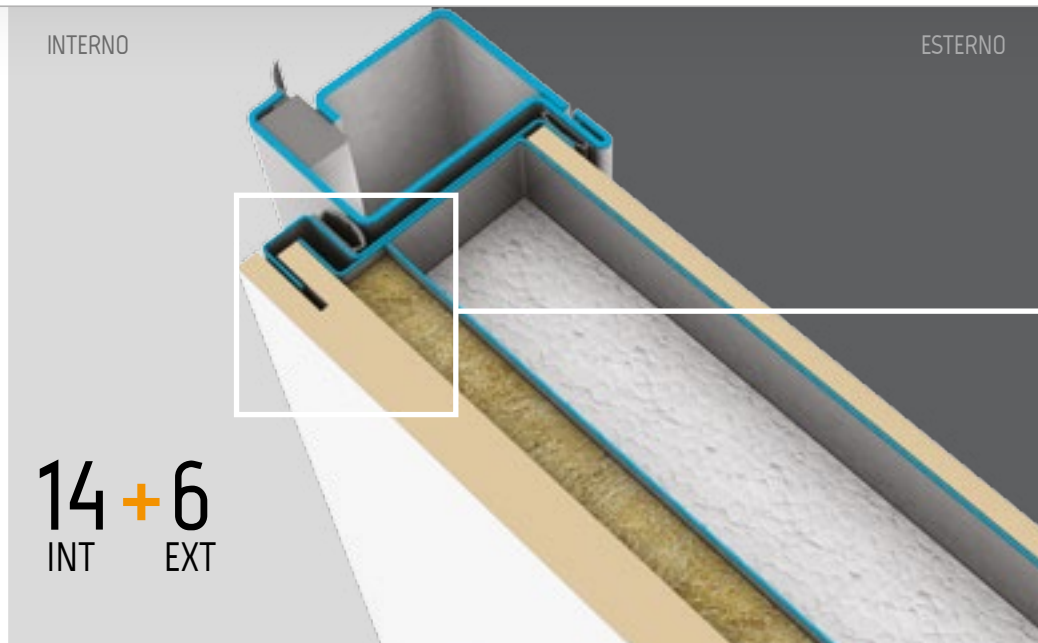

1 Soluzione telaio G standard
senza profili di copertura telaio lato interno

SOLUZIONI DI POSA CON ANTA STANDARD

Style & Project

Sui modelli con cerniere standard sono proposti 4 tipologie di telai per adattarsi a tutte le soluzioni di posa. Nelle immagini riportiamo diverse situazioni di posa con il telaio tipo G. Qui sotto sono riportate le sezioni dei 4 telai disponibili.

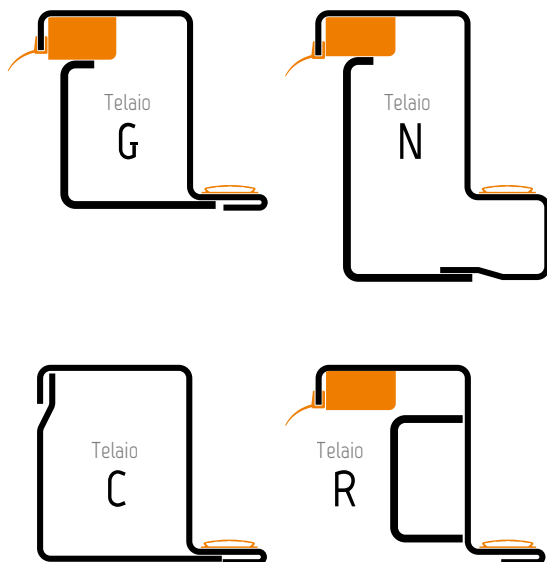

2 Soluzione telaio G filo muro esterno con
coprifilo con aletta per copertura interna

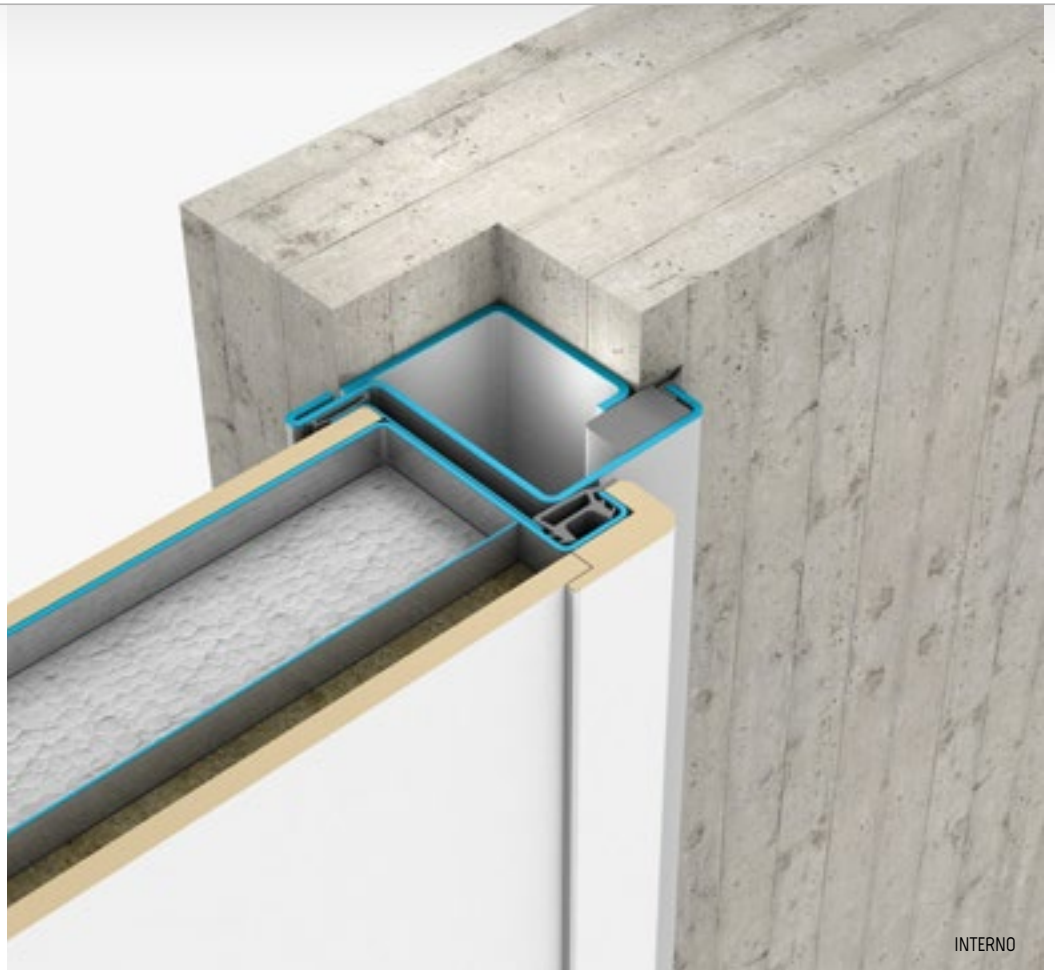

Soluzioni lato interno

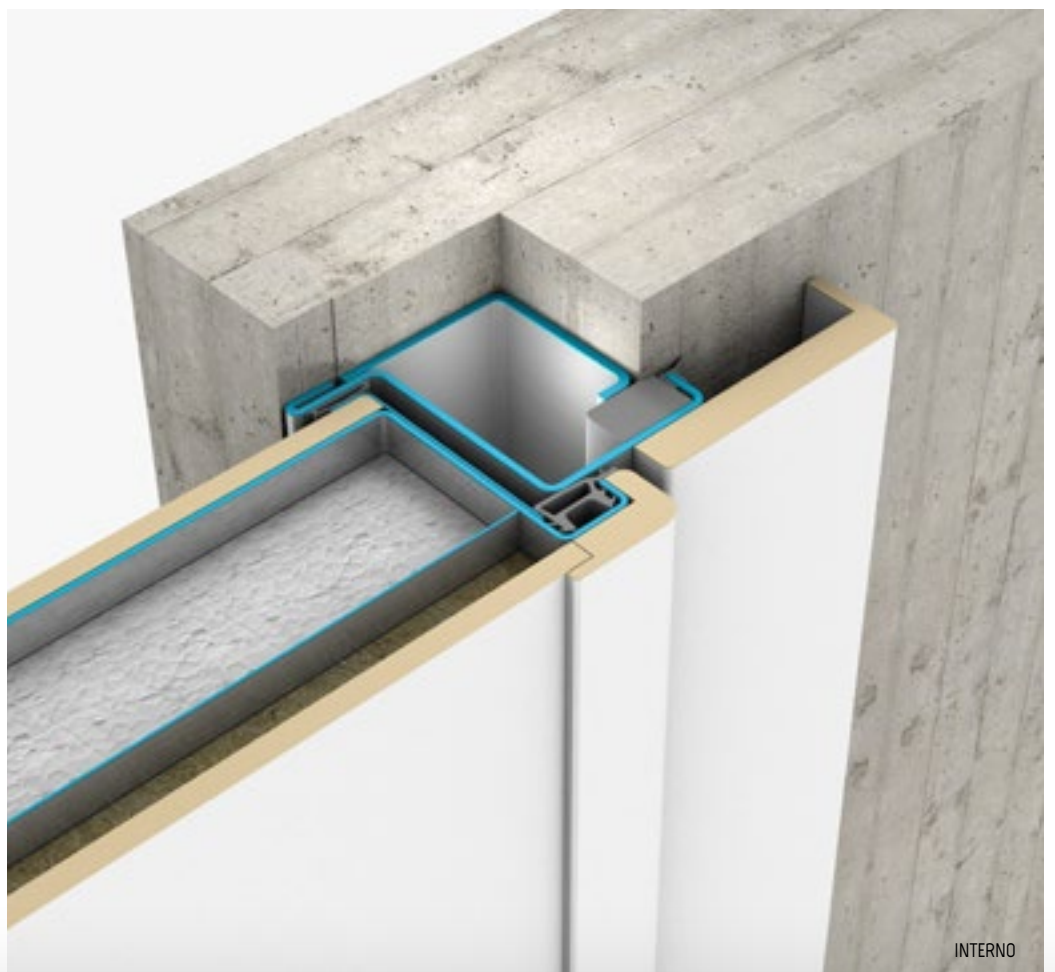

Soluzioni lato esterno

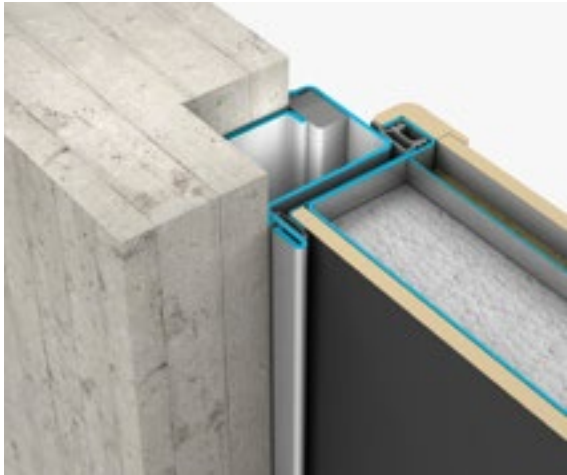

3 Soluzione telaio G standard senza profili di copertura telaio

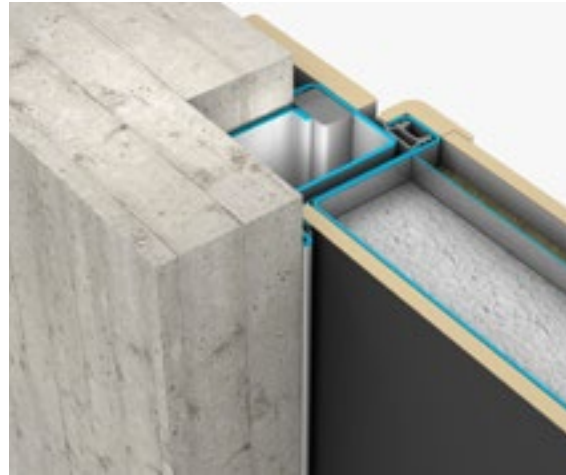

4 Soluzione telaio G filo muro esterno

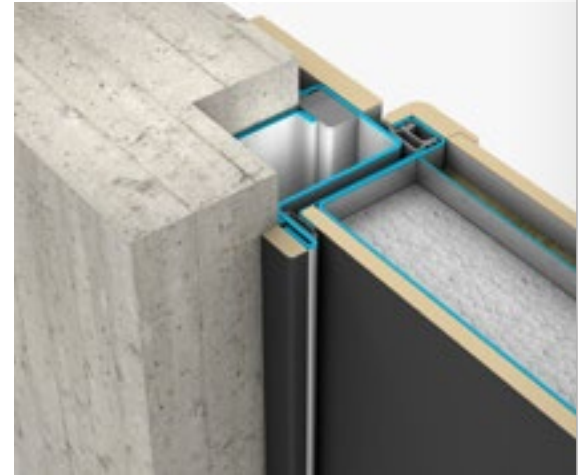

5 Soluzione telaio G standard con profili di copertura telaio esterno

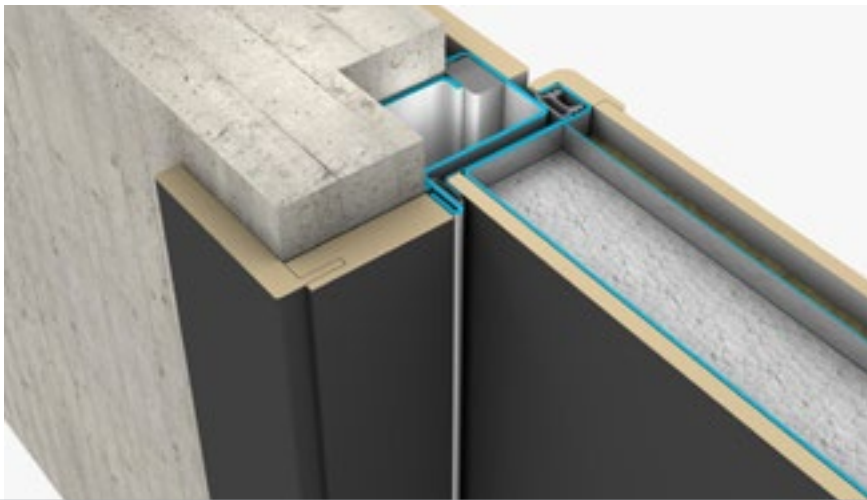

6 Soluzione telaio G con passata (imbotte) in legno lato esterno

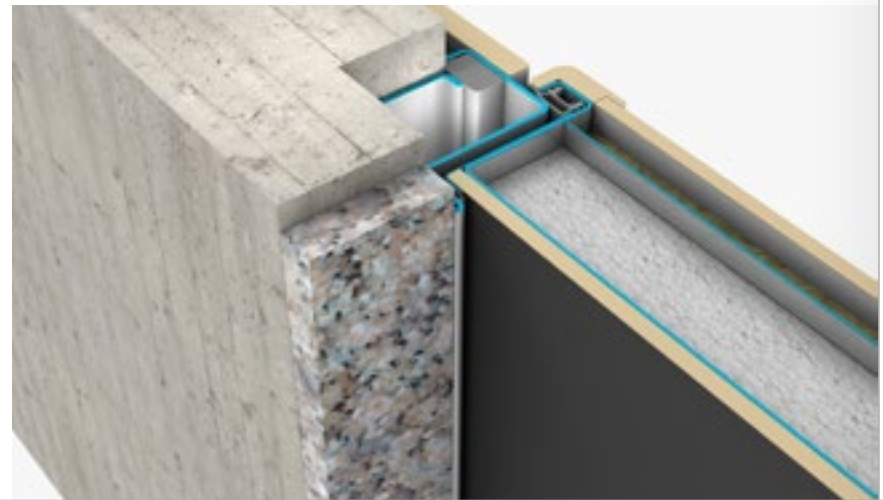

7 Soluzione telaio G con marmo o pietra esistente lato esterno

Soluzioni centro muro

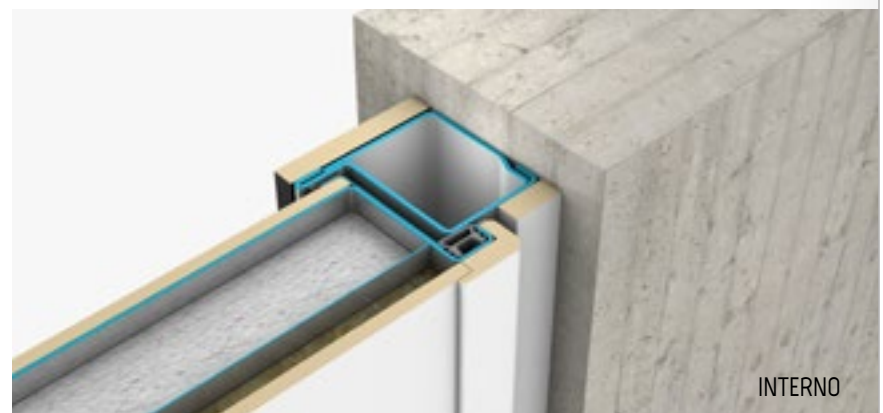
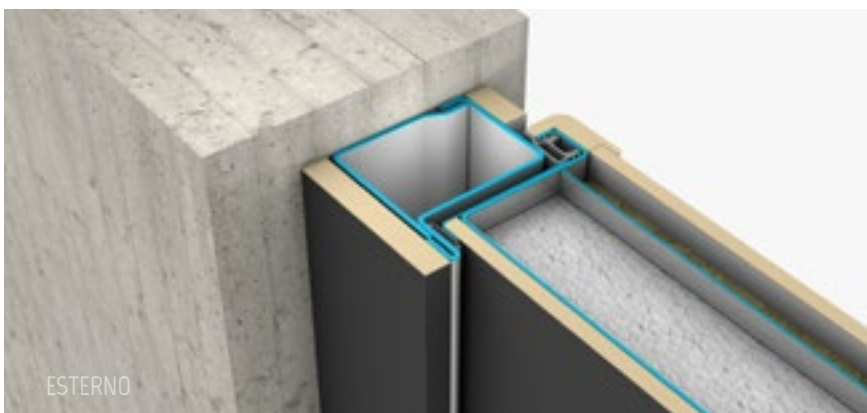

8 Soluzione posa telaio C centro muratura con profili di copertura telaio interni ed esterni.



Serrature

Scegliere la serratura di una porta blindata non è solo una questione di sicurezza, ma anche il modo migliore di personalizzare l'utilizzo della porta in base alle proprie esigenze.



Protezione mandate

Protezione mandate serratura in lamiera saldata sul telaio. Aumenta la sicurezza contro lo scasso della serratura ed impedisce spifferi o infiltrazioni d'aria.

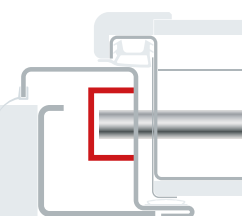



Serratura elettronica

Serrature ad azionamento elettronico con apertura tramite dispositivi differenti dalle solite chiavi: smartphone, tastiera, card, trasponder, telecomando, lettore di impronte digitali,...

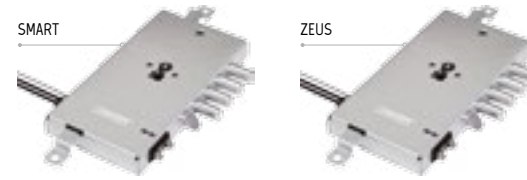

Doppia serratura interbloccante

Doppia sicurezza garantita dall'utilizzo di una serratura padronale e una di servizio. La chiusura di quella padronale, oltre ad azionare il catenaccio superiore, impedisce l'azionamento delle mandate della serratura di servizio. È possibile installare 2 cilindri standard indipendenti, o i cilindri SP che permettono al padrone di casa di azionare entrambe le serrature con una sola chiave.



Doppia serratura

Doppia sicurezza garantita da due serrature indipendenti (padronale e di servizio). La serratura di servizio aziona tutte le mandate, la serratura padronale aziona solo il catenaccio superiore. È possibile installare 2 cilindri standard indipendenti, o i cilindri SP che permettono al padrone di casa di azionare entrambe le serrature con una sola chiave.



Serratura singola

Serratura singola con azionamento mandate tramite cilindro europeo o chiave doppia mappa. La serratura Mercurio è la scelta migliore per tutte quelle porte blindate installate in ambienti di lavoro o ad alto affollamento. I maniglioni antipanico sono essenziali per una corretta via di fuga.

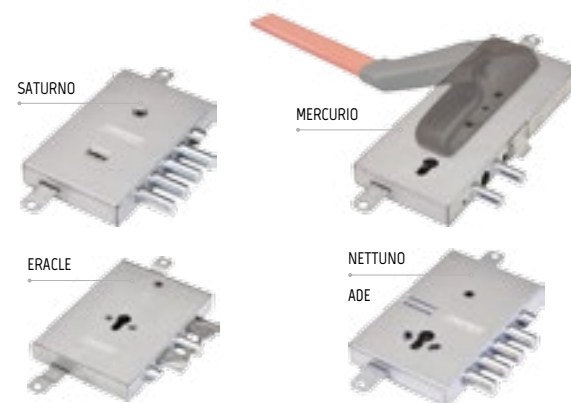

Serratura Fastlock

Serratura che può chiudere o aprire totalmente le mandate attraverso l'utilizzo della sola maniglia. Dal lato esterno per l'apertura è necessaria la chiave.





LATO INTERNO

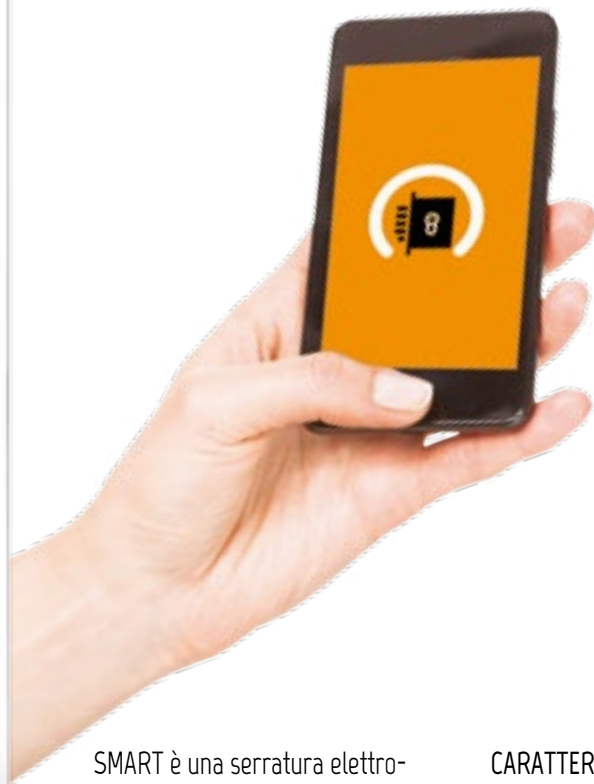

Serratura elettronica

Smart



MODALITÀ OPERATIVE

- 1 Chiusura automatica di tutti i punti di chiusura all'accostamento della porta e apertura totale compreso lo scrocco a seguito comando di apertura
- 2 Pari alla modalità 1 senza richiamo dello scrocco e richiusura automatica delle mandate in 10-15 secondi in caso di mancato accesso (consigliata maniglia esterna)
- 3 Disattivazione chiusura automatica all'accostamento, chiusura attivabile con comando operatore. Indicato per uffici o luoghi pubblici
- 4 Pari alla modalità 3 senza richiamo dello scrocco (consigliata maniglia esterna)
- 5 Azionamento automatico del solo scrocco con chiusura totale solo con chiave meccanica

CARATTERISTICHE PRINCIPALI

2 Configurazioni di alimentazione:

- di serie alimentazione diretta dalla rete (alimentatore compreso);
- a richiesta alimentazione diretta dalla rete con set batterie alcaline per funzionamento in assenza di corrente elettrica (20.000 aperture).

3 Configurazioni apertura dal lato esterno:

- di serie con lettore RFID + BLUETOOTH;
- a richiesta con tastiera numerica con lettore RFID + BLUETOOTH;
- optional lettore biometrico con 99 impronte digitali memorizzabili.

Comandi operatore di apertura e chiusura (in base alla configurazione)

- Tramite Smartphone
- Tramite Card
- Tramite Codice tastiera
- Tramite pulsantiera interna
- Tramite Pulsante remoto (solo apertura)

SMART è una serratura elettronica motorizzata azionabile con card e tags o tramite Bluetooth con smartphones di ultima generazione, che possono essere aggiunti o rimossi tramite l'app Argo disponibile per iOS e Android che permette di:

- aggiungere nuovi dispositivi di apertura (fino a 300 dispositivi)
- rinominare a piacere tutti i dispositivi di apertura
- leggere lo storico degli eventi e memorizzare fino a 1000 eventi
- cancellare credenziali perse o rubate di sistemi di apertura
- registrare codici VIP e standard. I codici VIP possono limitare l'accesso ai codici standard
- aggiornamento continuo delle funzionalità software tramite smartphone

Funziona anche senza alcuna connessione ad internet poiché l'app Argo si collega direttamente alla serratura attraverso l'ultima generazione di protocolli di criptazione assicurando i più alti livelli di sicurezza nel trasferimento dei dati.

Apertura dal lato interno semplicemente premendo il tasto posto sulla mostrina interna. È possibile disattivare il tasto per evitare aperture involontarie o in caso di presenza di bambini. Cavo multipolare per comandi remoti di serie che permette di azionare la serratura, utile per ingressi di uffici e aziende o per ingressi condominiali comuni con comando collegato ai citofoni dei singoli appartamenti. Apertura e chiusura di emergenza della porta può essere effettuata in modalità meccanica con la chiave del cilindro.

Configurazione di serie

DISPOSITIVI SULLA PORTA LATO INTERNO:

Pulsantiera con tasto di apertura/chiusura e programmazione della serratura

DISPOSITIVI SULLA PORTA LATO ESTERNO:

lettore RFID e BLUETOOTH

DOTAZIONI DI SERIE

n. 3 Card Master per la programmazione della serratura

n. 5 Card utente + n. 5 braccialetti RFID

MODALITÀ DI AZIONAMENTO DELLA SERRATURA

Le mandate della serratura vengono comandate con card utente e smartphone. È possibile ricodificare le card per un numero infinito di volte o aggiungere card o altri dispositivi con RFID integrato



Configurazione con tastiera numerica

DISPOSITIVI SULLA PORTA LATO INTERNO:

Pulsantiera con tasto di apertura/chiusura e programmazione della serratura

DISPOSITIVI SULLA PORTA LATO ESTERNO:

Tastiera numerica retroilluminata con lettore RFID e BLUETOOTH integrato

DOTAZIONI DI SERIE

n. 3 Card Master per la programmazione della serratura

n. 5 Card utente + n. 5 braccialetti RFID

MODALITÀ DI AZIONAMENTO DELLA SERRATURA

Le mandate della serratura vengono comandate con card utente, smartphone e codici numerici. Tastiera numerica in grado di memorizzare codici, da 4 a 8 cifre, riprogrammabili infinite volte.

La programmazione, la gestione degli accessi e gli aggiornamenti della serratura sono effettuabili solo via Smartphone con tessera Master.



Rispetto alla configurazione di serie ed alla configurazione con tastiera numerica è possibile aggiungere un lettore biometrico montato sulla parte esterna della porta, che consente di memorizzare fino a 99 impronte digitali differenti.

Braccialetto RFID





LATO INTERNO



Serratura elettronica

ZEUS

La serratura elettrica motorizzata consente l'apertura e chiusura della porta senza l'utilizzo della chiave ed attiva automaticamente le mandate di chiusura semplicemente accostando la porta.

CARATTERISTICHE PRINCIPALI

2 Configurazioni di alimentazione:

- di serie alimentazione diretta dalla rete (alimentatore compreso)
- a richiesta con batterie alcaline che consentono circa 30.000 aperture

4 Configurazioni apertura dal lato esterno:

- di serie con lettore RFID fornito con 5 card di apertura
- a richiesta con tastiera numerica fornita con 4 trasponder di apertura
- optional lettore biometrico con 99 impronte digitali memorizzabili
- optional radiocomando a distanza

MODALITÀ OPERATIVE

- 1 Chiusura automatica di tutti i punti di chiusura all'accostamento della porta e apertura totale compreso lo scrocco a seguito comando di apertura
- 2 Pari alla modalità 1 senza richiamo dello scrocco e richiusura mandate in 10-15 secondi in caso di mancato accesso (consigliata maniglia esterna)
- 3 Disattivazione chiusura automatica all'accostamento, chiusura attivabile con comando operatore. Indicato per uffici o luoghi pubblici
- 4 Pari alla modalità 3 senza richiamo dello scrocco (consigliata maniglia esterna)
- 5 Azionamento automatico del solo scrocco con chiusura totale solo con chiave meccanica

Apertura dal lato interno semplicemente premendo il tasto posto sulla mostrina interna. È possibile disattivare il tasto per evitare aperture involontarie o in caso di presenza di bambini. Cavo per comando remoto di serie che permette di azionare la serratura, utile per ingressi di uffici e aziende o per ingressi condominiali comuni con comando collegato ai citofoni dei singoli appartamenti. Possibilità di registrare card o trasponder e codici numerici in versione padronale e di servizio, disabilitabili o modificabili all'occorrenza. Apertura e chiusura di emergenza della porta può essere effettuata in modalità meccanica con la chiave del cilindro."



Radiocomando consente l'apertura della porta dall'esterno premendo il tasto registrato entro un raggio di circa 10 metri. I restanti due tasti sono disponibili per comandare in radiofrequenza altri dispositivi. Il ricevitore è alloggiato all'interno della porta.



Rispetto alla configurazione di serie ed alla configurazione con tastiera numerica è possibile aggiungere un lettore biometrico montato sulla parte esterna della porta, che consente di memorizzare fino a 99 impronte digitali differenti.

Configurazione di serie

DISPOSITIVI SULLA PORTA LATO INTERNO:

Pulsantiera con tasto di apertura/chiusura e programmazione della serratura

DISPOSITIVI SULLA PORTA LATO ESTERNO:

Lettoce RFID

DOTAZIONI DI SERIE

n. 5 Card utente

MODALITÀ DI AZIONAMENTO DELLA SERRATURA

Accostando la card al lettore le mandate della serratura si aprono automaticamente. È possibile ricodificare le card per un numero infinito di volte. Le card possono essere memorizzate a due livelli, padronale e servizio.



LATO ESTERNO

Configurazione con tastiera numerica

DISPOSITIVI SULLA PORTA LATO INTERNO:

Pulsantiera con tasto di apertura/chiusura e programmazione della serratura

DISPOSITIVI SULLA PORTA LATO ESTERNO:

Tastiera numerica retroilluminata con lettore RFID integrato

DOTAZIONI DI SERIE

n. 4 Trasponder (senza chiave meccanica)

MODALITÀ DI AZIONAMENTO DELLA SERRATURA

Accostando il trasponder alla tastiera le mandate della serratura si aprono automaticamente. La tastiera numerica è in grado di memorizzare fino a 128 codici, da 4 a 8 cifre, riprogrammabili infinite volte.

È quindi possibile memorizzare sia chiavi trasponder che codici numerici con funzione padronale e di servizio.

Le chiavi trasponder ed i codici padronali consentono di:

- aprire e chiudere la serratura
- cambiare le modalità operative di funzionamento
- attivare nuove chiavi o codici padronali
- attivare e disattivare le chiavi o i codici di servizio
- reset totale della memoria

Le chiavi trasponder ed i codici di servizio consentono:

- la sola apertura della serratura se abilitati.



LATO ESTERNO

ERACLE DS

ARGO

Doppia serratura interbloccante

2 CILINDRI SP

Configurazione di serie

Il padrone di casa ha una sola chiave per la serratura padronale e di servizio



La caratteristica principale di questo sistema di chiusura è che l'utilizzo del cilindro n. 1 inibisce l'utilizzo della chiave di servizio sul cilindro n. 2. Il possessore della chiave **PADRONALE** apre e chiude i cilindri 1 e 2 con una sola chiave, mentre il possessore della chiave di **SERVIZIO** apre solo il cilindro 2 quando non è attivo il sistema di blocco.

A PORTA IN **TOTALE** SICUREZZA

La chiave di Servizio **NON** è abilitata ad aprire la porta e non può azionare le mandate.

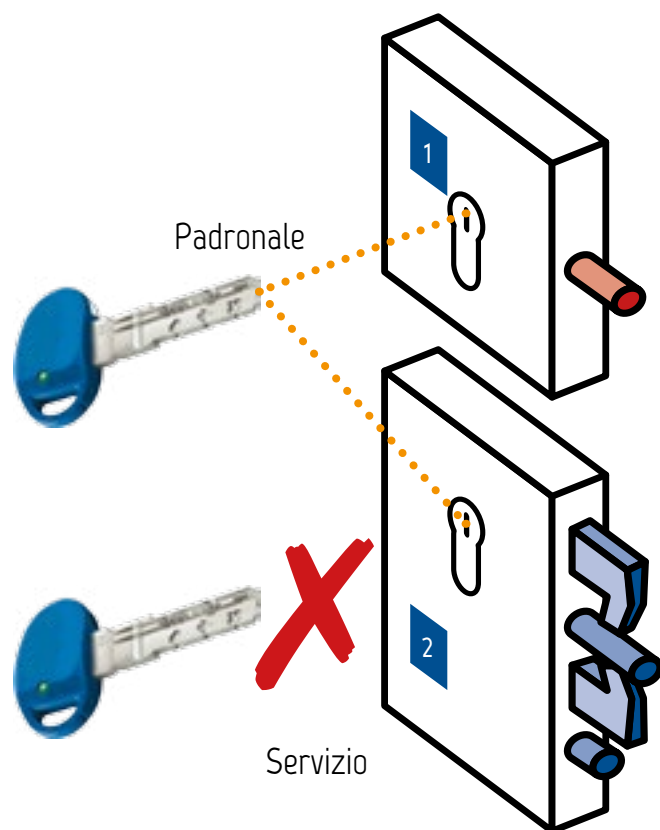

UTILIZZO DELLA SERRATURA CON BLOCCO SERRATURA DI SERVIZIO

IN CHIUSURA

- 1) Chiudere le mandate del cilindro n. 2 con chiave **PADRONALE**.
- 2) Chiudere il catenaccio del cilindro n. 1 con chiave **PADRONALE**. In questo modo viene attivato il sistema di blocco, impedendo al possessore della chiave di **SERVIZIO** di aprire la serratura.

IN APERTURA

- 1) Aprire il catenaccio del cilindro n. 1 con chiave **PADRONALE** per disattivare il sistema di blocco.
- 2) Aprire le mandate del cilindro n. 2 con chiave **PADRONALE**.

B PORTA IN SICUREZZA

La chiave di Servizio è abilitata ad aprire la porta.

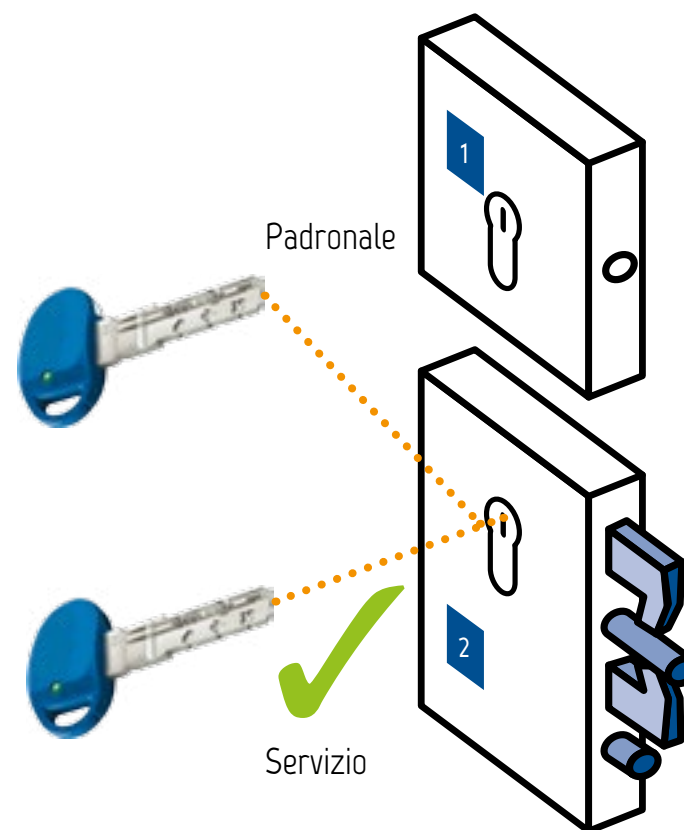

UTILIZZO DELLA SERRATURA CON LIBERO ACCESSO ALLA CHIAVE DI SERVIZIO

IN CHIUSURA

- 1) Chiudere le mandate solo del cilindro n. 2 con chiave **Padronale**. In questo modo il possessore della chiave di **Servizio** è abilitato ad aprire la serratura.

IN APERTURA

- 1) Aprire le mandate del cilindro n. 2 con chiave di **Servizio** o chiave **Padronale**.



La chiave padronale si riconosce dal tassellino bianco, quella di servizio dal tassellino blu.

ERACLE DS

ARGO

Doppia serratura interbloccante

2 CILINDRI INDIPENDENTI

Configurazione opzionale

Il padrone di casa ha due chiavi, una per la serratura padronale, una per la serratura di servizio.



La caratteristica principale di questo sistema di chiusura è che il cilindro 1 inibisce l'utilizzo della chiave di servizio. Ogni cilindro ha la sua chiave. Per chiudere in totale sicurezza la serratura è necessario essere in possesso di due chiavi, quella Padronale e quella di Servizio. Il possessore della chiave di Servizio apre solo il cilindro 2 quando non è attivo il sistema di blocco.

A PORTA IN TOTALE SICUREZZA

La chiave di Servizio NON è abilitata ad aprire la porta e non può azionare le mandate.

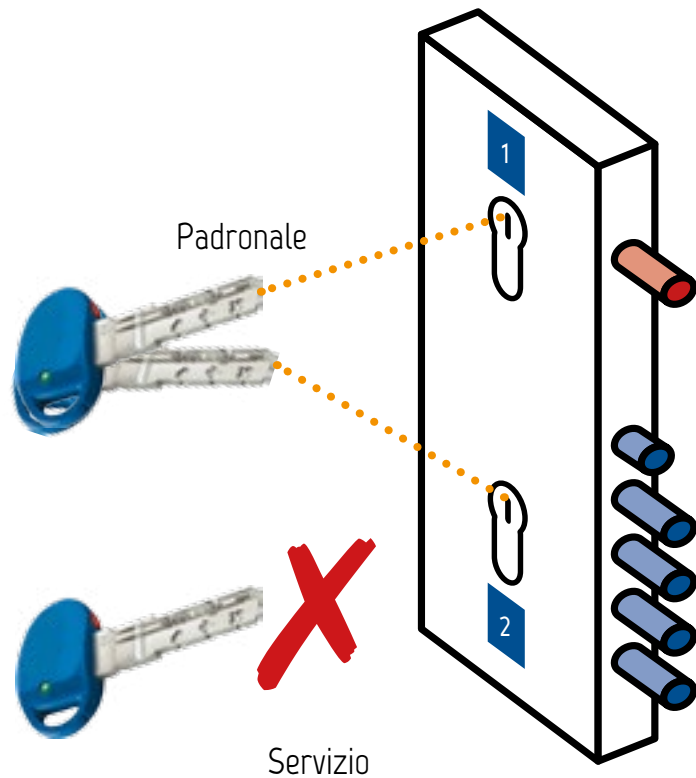

UTILIZZO DELLA SERRATURA CON BLOCCO SERRATURA DI SERVIZIO

IN CHIUSURA

- 1) Chiudere le mandate del cilindro n. 2 con chiave di Servizio.
- 2) Chiudere il catenaccio del cilindro n. 1 con chiave Padronale.

In questo modo viene attivato il sistema di blocco, impedendo al possessore della sola chiave di Servizio di aprire la serratura.

IN APERTURA

- 1) Aprire il catenaccio del cilindro n. 1 con chiave Padronale per disattivare il sistema di blocco.
- 2) Aprire le mandate del cilindro n. 2 con chiave di Servizio.

B PORTA IN SICUREZZA

La chiave di Servizio è abilitata ad aprire la porta.

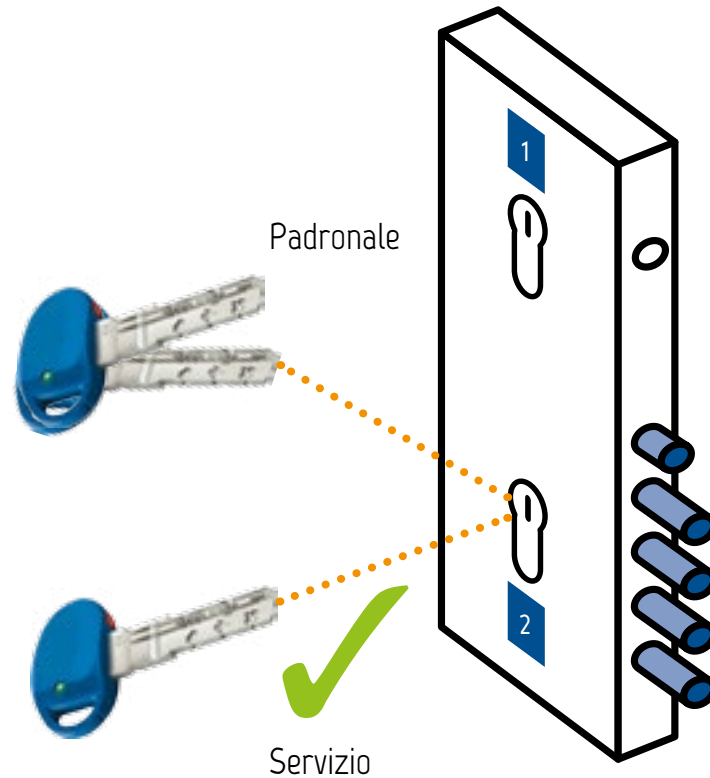

UTILIZZO DELLA SERRATURA CON LIBERO ACCESSO ALLA CHIAVE DI SERVIZIO

IN CHIUSURA

Chiudere le mandate solo del cilindro n. 2 con chiave di Servizio. In questo modo il possessore della chiave di Servizio è abilitato ad aprire la serratura.

IN APERTURA

Aprire le mandate del cilindro n. 2 con chiave di Servizio o chiave Padronale.



È possibile scegliere due cilindri differenti.
È consigliabile utilizzare un cilindro di maggior sicurezza sulla serratura di servizio

PLUTONE

MARTE

Doppia serratura

Il padrone di casa ha due chiavi, una per la serratura padronale, una per la serratura di servizio.

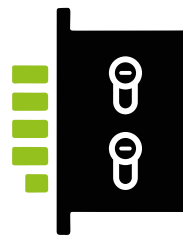

La caratteristica principale di questo sistema di chiusura è che ogni cilindro ha la sua chiave, ed è indipendente uno dall'altro. Per chiudere in totale sicurezza la serratura è necessario essere in possesso di due chiavi, quella Padronale e quella di Servizio. Il possessore della chiave di Servizio apre solo il cilindro 2.

A PORTA IN **TOTALE** SICUREZZA

La chiave di Servizio **NON** è abilitata ad aprire la serratura, può azionare le mandate, ma la porta è chiusa dal catenaccio superiore.

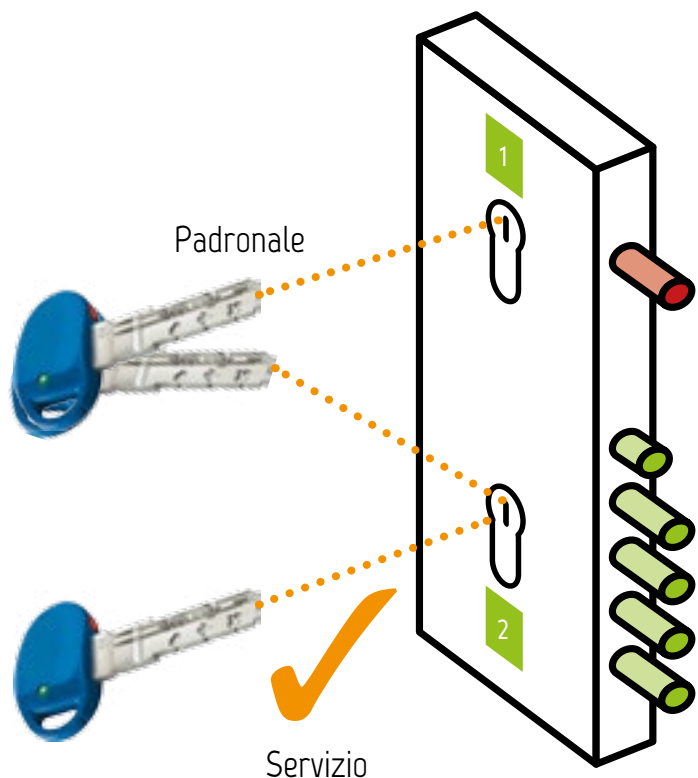

UTILIZZO DELLA SERRATURA CON BLOCCO SERRATURA DI SERVIZIO

IN CHIUSURA

1) Essendo cilindri indipendenti, è possibile chiudere indifferentemente prima il cilindro 1 con chiave Padronale o il cilindro 2 con chiave di Servizio.

IN APERTURA

1) Aprire indifferentemente prima il cilindro 1 con chiave Padronale o il cilindro 2 con chiave di Servizio.

B PORTA IN SICUREZZA

La chiave di Servizio è abilitata ad aprire la porta.

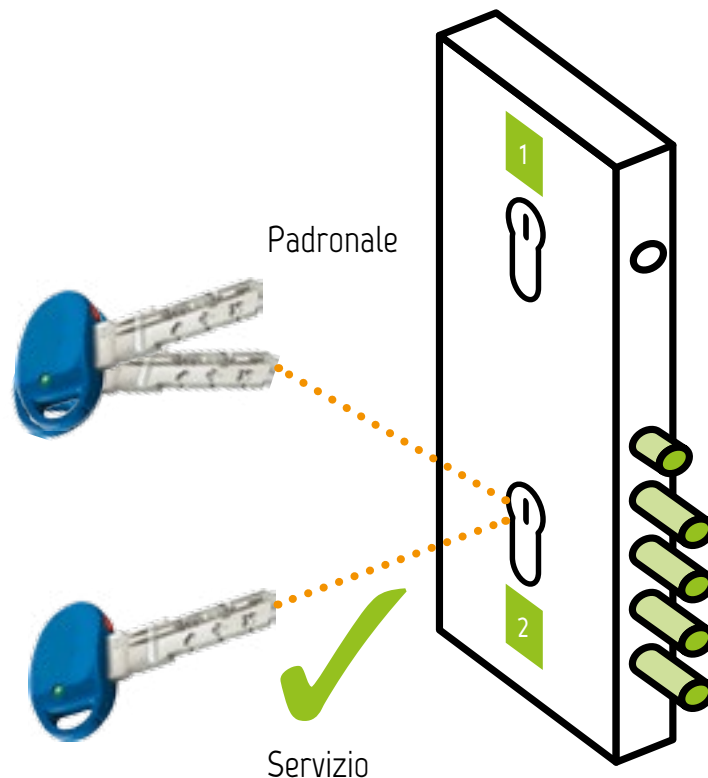

UTILIZZO DELLA SERRATURA CON LIBERO ACCESSO ALLA CHIAVE DI SERVIZIO

IN CHIUSURA

1) Chiudere le mandate solo del cilindro n. 2 con chiave di Servizio. In questo modo il possessore della chiave di Servizio è abilitato ad aprire la serratura.

IN APERTURA

1) Aprire le mandate del cilindro n. 2 con chiave di Servizio.

**PLUTONE**

È possibile scegliere due cilindri differenti. È consigliabile utilizzare un cilindro di maggior sicurezza sulla serratura di servizio

**MARTE**

La serratura Marte prevede un cilindro e una doppia mappa

ERACLE

NETTUNO + ADE

SATURNO

MERCURIO



Serratura singola

1 CILINDRO O DOPPIA MAPPA

La caratteristica principale di questo sistema di chiusura è che è possibile installare un solo cilindro oppure un solo sistema di azionamento a doppia mappa. La selezione del cilindro fa la differenza nelle funzioni di apertura: ad esempio montando i cilindri CPS è possibile ottenere funzioni di chiavi padronali e di servizio. Per altre soluzioni consulta la sezione dedicata ai cilindri (pag. 86).



Serratura Fastlock

Oltre al normale uso della chiave è possibile azionare la serratura con la maniglia:

CHIUSURA

azionando la maniglia verso l'alto si chiude la porta sia dall'interno che dall'esterno.

APERTURA

per l'apertura dal lato esterno è necessaria la chiave, mentre dal lato interno è sufficiente ruotare la maniglia verso il basso (tale funzione d'emergenza è disattivabile agendo sul perno posizionato sopra la serratura).



Attenzione: per disabilitare l'apertura di emergenza delle mandate con la maniglia sul lato interno è necessario ruotare di 180° il perno posto in battuta sopra la serratura.



IN APERTURA DALL'ESTERNO: l'apertura della porta dal lato esterno è possibile solo con l'utilizzo della chiave.



IN CHIUSURA DALL'ESTERNO: è possibile chiudere la porta senza l'ausilio delle chiavi, ma solamente ruotando la maniglia verso l'alto.



IN APERTURA DALL'INTERNO: solo dall'interno è possibile aprire la porta ruotando la maniglia verso il basso. Questa funzione è disattivabile.



IN CHIUSURA DALL'INTERNO: semplicemente ruotando la maniglia verso l'alto è possibile mettere in totale sicurezza la porta.

Optional di sicurezza

La sicurezza non è mai troppa, ecco perchè la Stark ti può offrire una serie di optional che contribuiscono a rendere ancora più sicuro il tuo portoncino blindato.



SENSORE DI ALLARME 3

Sensore magnetico, rileva lo scostamento della porta, da collegare ad impianti antifurto esistenti.



1 DEFENDER CON ALLARME

Dispositivo di protezione dotato di allarme in grado di rilevare tentativi di effrazione.

- Led lampeggiante esterno con funzione di dissuasione.
- Sensore a strappo per la difesa della serratura.
- Sirena di segnalazione allarme (bitonale).
- Led per segnalazioni di servizio interno.



2 DEFENDER ROTATIVO MAGNETICO

Sistema di protezione magnetico con spina in widia (carburo di tungsteno). Nasconde il foro chiave impedendo tentativi di manomissione o attacchi vandalici.

VANTAGGI

- Protezione del cilindro da attacchi bumping
- Protezione del cilindro da attacchi picking
- Possibilità di utilizzo con funzione padronale e servizio

4

4 BLOCCA ASTE ELETTRONICO

Blocca aste elettronico da abbinare a qualsiasi serratura meccanica singola, a bloccaggio verticale senza chiusura laterale.

- Dispositivo di blocco serratura con tastiera numerica esterna e volantino interno. Il bloccaggio dell'asta impedisce l'apertura della serratura anche se in possesso della chiave
- La tastiera permette la registrazione di 1 codice di programmazione e di 1 codice da 6 a 8 cifre per bloccare e sbloccare la serratura.
- La procedura di blocco e sblocco è attivabile solo a serratura chiusa
- È autonomo grazie alla batteria da 9 Volts incorporata che garantisce 15.000 azionamenti. In caso di batteria scarica il sistema si blocca consentendo lo sblocco interno o l'alimentazione esterna mediante batteria e connessione di emergenza su mostrina.
- Sicuro! Efficace contro le più comuni tecniche di effrazione, bumping, picking o chiave bulgara

ESTERNO

INTERNO

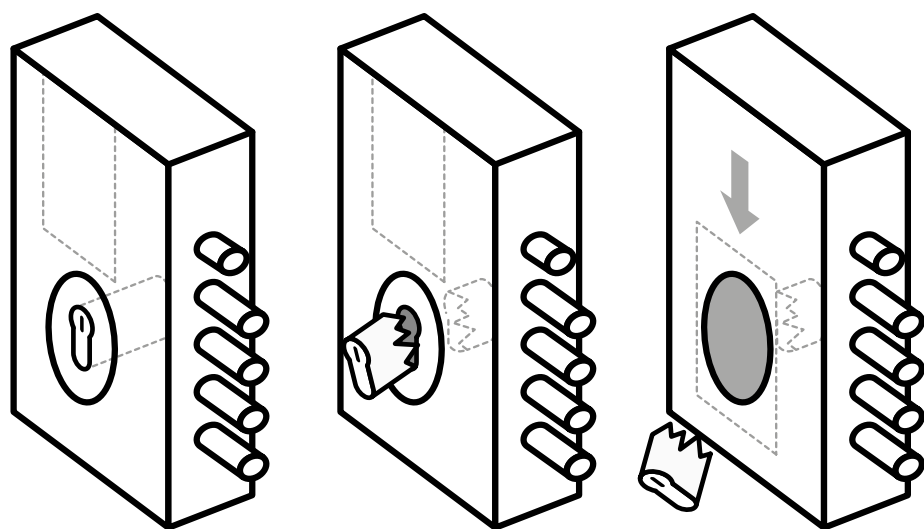

Guarda il video sul nostro canale Youtube:
[Youtube/starksicurezza/serratura con trappola](https://www.youtube.com/channel/UCstarksicurezza/serratura%20con%20trappola)



5 SERRATURA CON TRAPPOLA

Dispositivo interno alla serratura che scatta bloccando il richiamo delle mandate in caso di estrazione forzata del cilindro, entra in funzione solamente con serratura chiusa in ultima mandata. Il processo è irreversibile e richiede la sostituzione della serratura. Disponibile a richiesta su serratura ERACLE, ERACLE-DS, ERACLE-FL, NETTUNO, ARGO, PLUTONE

Il dispositivo con trappola è **irreversibile**, una volta scattato occorre sostituire la serratura. Ogni portoncino con tale dispositivo è contrassegnato da un adesivo.











Cilindri

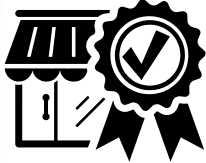

Scegliere il cilindro di una porta blindata non è solo una questione di sicurezza, ma anche il modo migliore di personalizzare l'utilizzo della porta in base alle proprie esigenze.

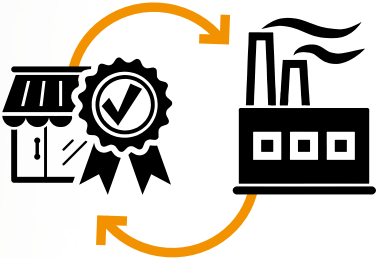

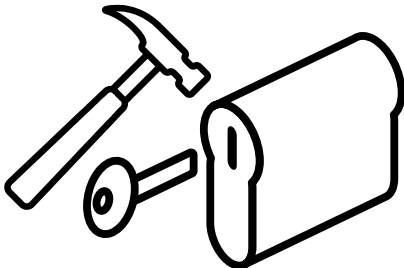
Parametri per la definizione della **sicurezza dei cilindri**

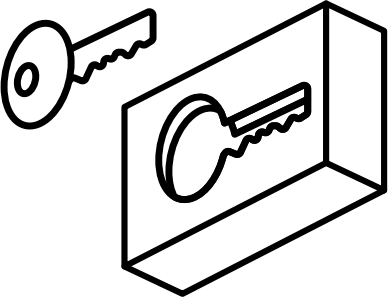
<p>KDL chiave a duplicazione libera</p>			<p>La chiave può essere duplicata anche senza esibizione della tessera, con la sola presentazione della chiave presso qualsiasi ferramenta.</p>
<p>KDP chiave a duplicazione protetta</p>			<p>La chiave può essere duplicata solo da un "centro specializzato" con la presentazione di una chiave originale + la tessera per attestare la proprietà della chiave.</p>
<p>KDPC chiave a duplicazione protetta e garantita</p>			<p>La chiave può essere duplicata tramite un "centro specializzato" che provvede all'invio in fabbrica dei dati relativi alla chiave originale + la tessera. Solo il costruttore è in grado di effettuare la duplicazione. La consegna della chiave richiede alcuni giorni per la realizzazione.</p>
<p>BKP cilindri certificati anti bumping e picking</p>	 <p>Guarda il video sul nostro canale Youtube: Youtube/starksicurezza/attacco bumping </p>		<p>I cilindri antibumping sono certificati come RESISTENTI al Bumping e Picking al massimo livello stabilito dalla norma VOLONTARIA di riferimento. Il Bumping si basa sull'impiego di un martelletto flessibile che, utilizzato con destrezza, porta all'allineamento forzato dei perni e alla conseguente apertura del cilindro. Il Picking è la tecnica di decodifica della cifratura della chiave mediante grimaldelli o attrezzi specifici.</p>
<p>TRC cilindri certificati anti tracing</p>			<p>La cifratura è protetta dalla tecnica di manipolazione che si basa sul "ricalco", detta anche "impressione". I controlli profilo laterali, superiori e sagomati "in Asse", presenti sulle chiavi sono progettati in modo tale che, in caso di chiave contraffatta, i controperni vadano "in trappola" impedendo la rotazione di chiave e rotore, bloccando inoltre l'estrazione della chiave stessa o dell'attrezzo di manipolazione in modo irreversibile.</p>



A PREDISPOSIZIONE VOLANTINO

Tutte le tipologie dei nostri cilindri possono essere forniti con il volante dal lato interno. Il vantaggio è quello di chiudere ed aprire la porta senza l'utilizzo della chiave.

B CILINDRO FRIZIONATO

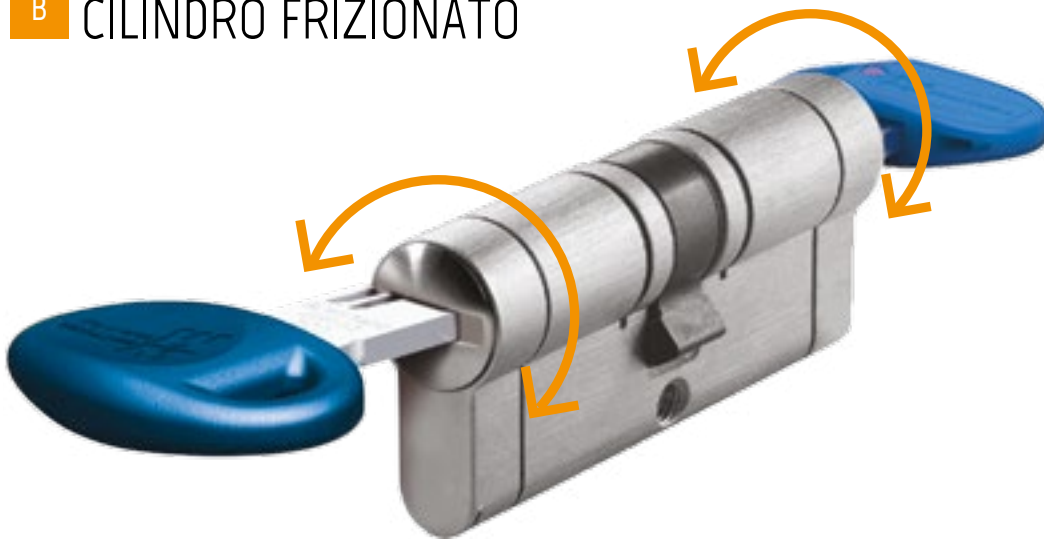

È di serie su tutti i nostri portoncini blindati. La sua caratteristica è quella di permettere l'apertura dall'esterno anche se è inserita la chiave all'interno.

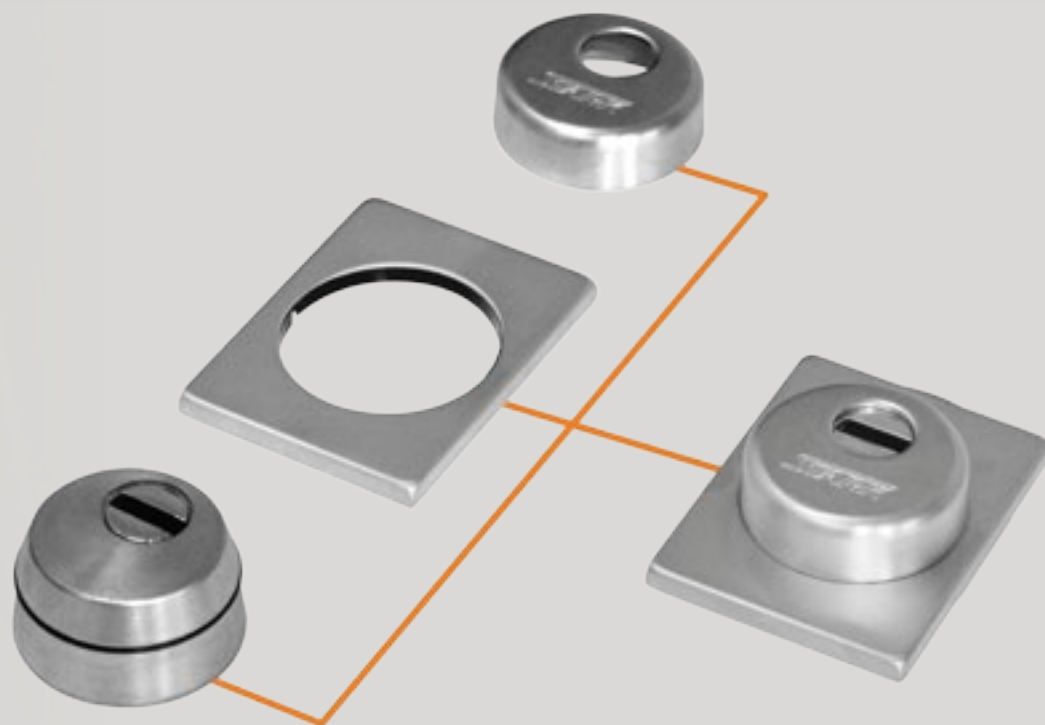









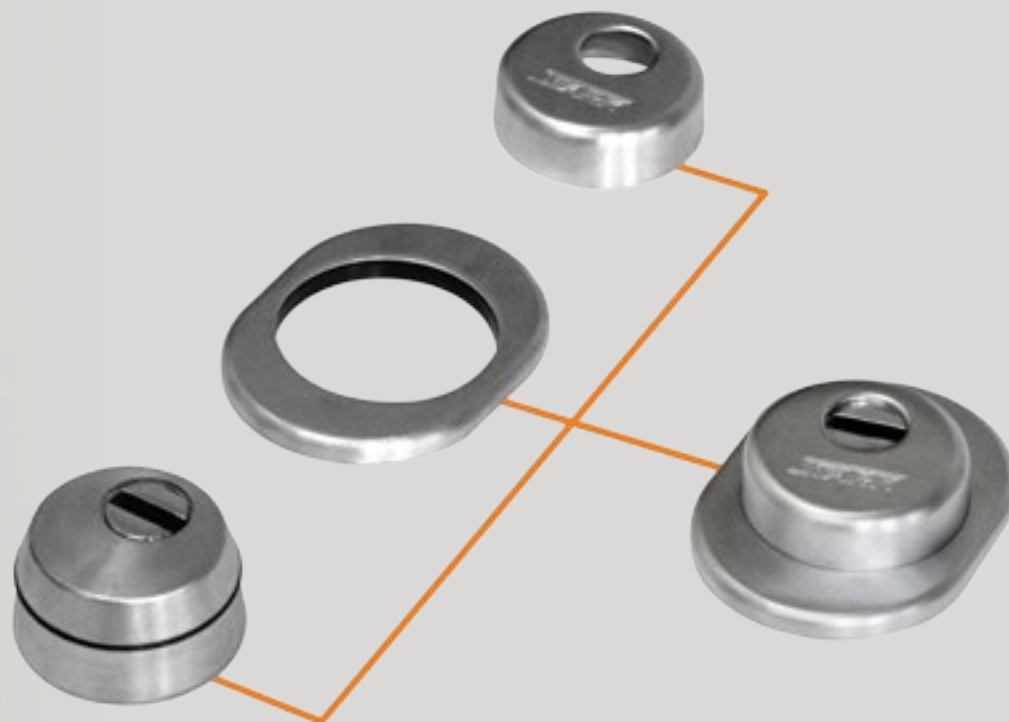



C DEFENDER CONICO



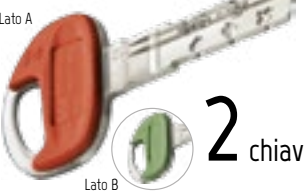



Il defender è la parte che protegge direttamente il cilindro e ne impedisce qualunque manomissione.



Guarda il video sul nostro canale Youtube:
[Youtube/starksicurezza/defender conico stark](https://www.youtube.com/watch?v=starksicurezza/defender-conico-stark)



	DESCRIZIONE	CHIAVI E ALTRI STRUMENTI DI APERTURA
AS5	5 chiavi padronali con impugnatura gommata + scheda di duplicazione che ha la funzione di attestare la proprietà della chiave, ma non rende la duplicazione sicura	<p>1^a vita</p>  <p>5 chiavi</p>
CPRO 5+1	5 chiavi padronali + 1 chiave padronale di 2 ^a vita + schede di duplicazione. In caso di smarrimento o furto di una delle 5 chiavi di 1 ^a vita è sufficiente inserire nel cilindro la chiave di 2 ^a vita per escludere automaticamente le chiavi usate precedentemente. In questo caso le chiavi di 1 ^a vita non saranno più utilizzabili	<p>1^a vita</p>  <p>5 chiavi</p> <p>2^a vita</p>  <p>1 chiave</p>
CPRO 5+5	5 chiavi padronali + 5 chiavi padronali di 2 ^a vita + schede di duplicazione. In caso di smarrimento o furto di una delle 5 chiavi di 1 ^a vita è sufficiente inserire nel cilindro la chiave di 2 ^a vita per escludere automaticamente le chiavi usate precedentemente. In questo caso le chiavi di 1 ^a vita non saranno più utilizzabili	<p>1^a vita</p>  <p>5 chiavi</p> <p>2^a vita</p>  <p>5 chiavi</p>
CPS	2 chiavi di attivazione padronali + 3 chiavi padronali + 1 chiave di servizio + schede di duplicazione. Le chiavi padronali e servizio funzionano entrambe sullo stesso cilindro. Fornito con 2 chiavi di attivazione (padronali) per attivare e disattivare la chiave di servizio	<p>Attivazione</p> <p>Lato A</p>  <p>Lato B</p> <p>2 chiavi</p> <p>Padronali</p>  <p>3 chiavi</p> <p>Servizio</p>  <p>1 chiave</p>
C48	5 chiavi padronali + 1 chiave padronale di 2 ^a vita + schede di duplicazione. In caso di smarrimento o furto di una delle 5 chiavi di 1 ^a vita è sufficiente inserire nel cilindro la chiave di 2 ^a vita per escludere automaticamente le chiavi usate precedentemente. In questo caso le chiavi di 1 ^a vita non saranno più utilizzabili	<p>1^a vita</p> <p>Lato A</p>  <p>Lato B</p> <p>5 chiavi</p> <p>2^a vita</p> <p>Lato A</p>  <p>Lato B</p> <p>1 chiave</p>
DOPPIO SP	5 chiavi padronali che aprono entrambi i cilindri + 3 chiavi di servizio che aprono solo il cilindro di servizio	<p>Padronali</p>  <p>5 chiavi</p> <p>Servizio</p>  <p>3 chiavi</p>

CILINDRI	FRIZIONATO	SICUREZZA DUPLICAZIONE	PREDISPOSIZ. VOLANTINO	ANTI BUMPING	ANTI TRACING	CILINDRO CANTIERE	SERRATURE									
							ERACLE/DS	ARGO	PLUTONE	ERACLE/FL	ERACLE	NETTUNO	ADE	MERCURIO	SATURNO	MARTE
	✓	KDL	✓	✗	✗	✓	✗	✓	✓	✗	✗	✓	✓	✓	✗	✓
		KDP	✓	✓	✓		✓	✓	✓	✓	✓	✓	✓	✓	✗	✓
		KDP	✓	✓	✓		✓	✓	✓	✓	✓	✓	✓	✓	✗	✓
		KDP	✓	✓	✓		✓	✗	✗	✗	✓	✓	✓	✓	✗	✗
		KDPG	✓	✓	✓		✓	✓	✓	✓	✓	✓	✓	✓	✗	✓
		KDP	SU ENTRAMBE LE CHIUSURE O SOLO SU SERRATURA DI SERVIZIO	✓	✓		✓	✓	✓	✓	✗	✗	✗	✗	✗	✗

CILINDRO C48



Cilindro con doppio sistema di cifratura, curva desmodromica ed elemento mobile sulla chiave.

Cilindro top di gamma con duplicazione protetta e controllata realizzata in azienda tramite i centri autorizzati Mottura Club.



- Cilindro a rottura controllata in caso di effrazione.
- Doppio sistema di cifratura meccanico: uno con perni a molla, l'altro abbinato a perni coassiali, rotanti sulla curva desmodromica. Controlli profilo laterali "in Asse" brevettati che, in caso di picking, bumping e tracing, bloccano in modo irreversibile il cilindro, impedendone l'apertura. Con decine di milioni di combinazioni è ideale per impianti masterizzati complessi.
- Spine, tappi e perni ad elevata durezza per aumentare la sicurezza alla perforazione. Perni e contro-pistoncini con profilatura anti grimaldello.
- Chiavi con profilo brevettato.

CILINDRO CPS



Cilindro con funzione padronale/servizio.

Un'innovazione tecnica di assoluto rilievo: le chiavi padronali e di servizio funzionano entrambe sullo stesso cilindro, ma con la chiave "Armo/riarmo" è possibile disabilitare temporaneamente la chiave di servizio e poi ripristinarla in un secondo momento. Ad esempio, partendo per le vacanze, si può precludere l'accesso ai possessori di chiavi di servizio e ripristinarlo al ritorno.

DOTAZIONE DI SERIE 2 + 3 + 1

Attivazione



2 chiavi di attivazione con un lato verde ed uno rosso, da utilizzare per attivare/disattivare la chiave di servizio

Padronali



3 chiavi padronali che consentono sempre il normale uso del cilindro

Servizio



1 chiave di servizio

CHIAVE DI SERVIZIO ATTIVA

Inserire la chiave con il lato verde verso l'alto: la chiave di servizio funziona normalmente. Il cilindro viene aperto sia dalla chiave padronale blu sia dalla chiave di servizio turchese.

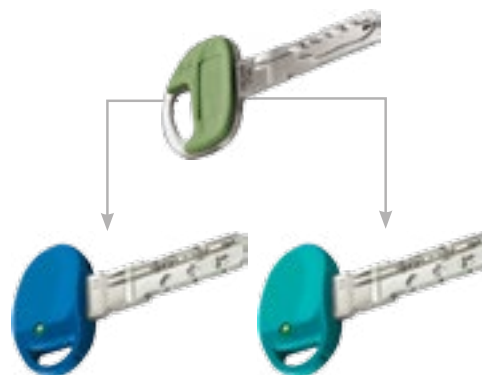

CHIAVI DI SERVIZIO DISATTIVA

Inserire la chiave con il lato rosso verso l'alto: la chiave di servizio NON funziona. Il cilindro viene aperto solo dalla chiave Padronale blu.

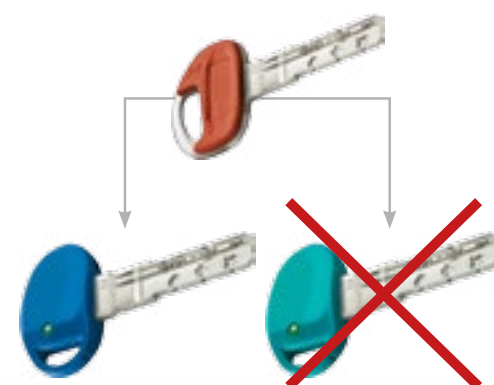

Sistemi personalizzati per accessi combinati

Disponibili solo su cilindri dello stesso modello.

A SISTEMA KA

Con una chiave apro tutti i miei ingressi!

FUNZIONE: tutte le porte sono aperte dalla stessa chiave.
ESEMPIO: in abitazioni: con una chiave apro l'ingresso principale, l'ingresso secondario e la cantina. In ufficio: con una chiave apro l'ingresso, e le porte di diversi uffici, il magazzino ecc.

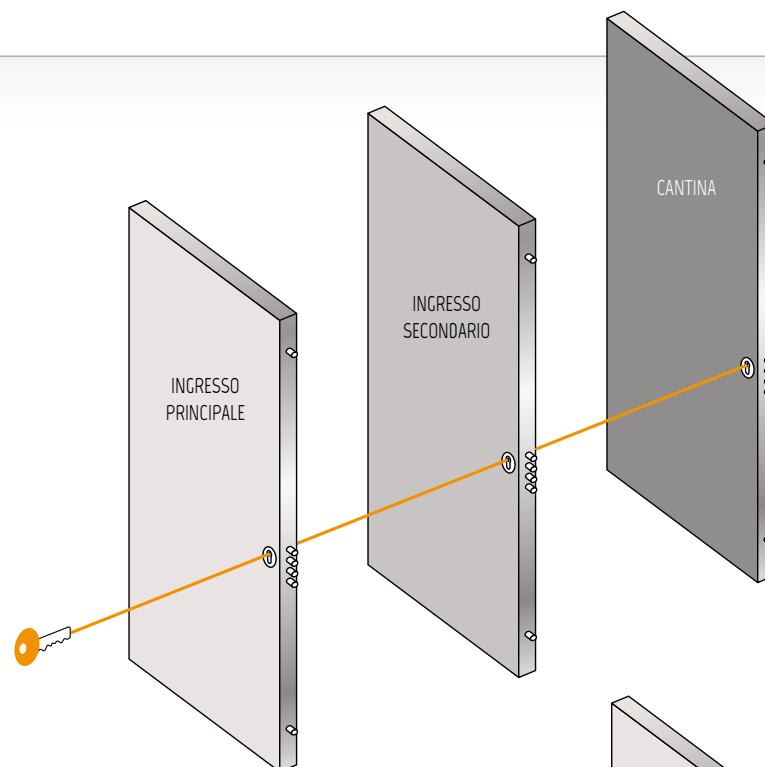

B SISTEMA CE

Con la mia chiave apro tutti gli ingressi comuni!

FUNZIONE: uno o più porte sono aperte da due o più chiavi.
ESEMPIO: usato in stabili di diversi appartamenti. Ogni inquilino apre con la stessa chiave il suo appartamento ed il portoncino d'ingresso comune.

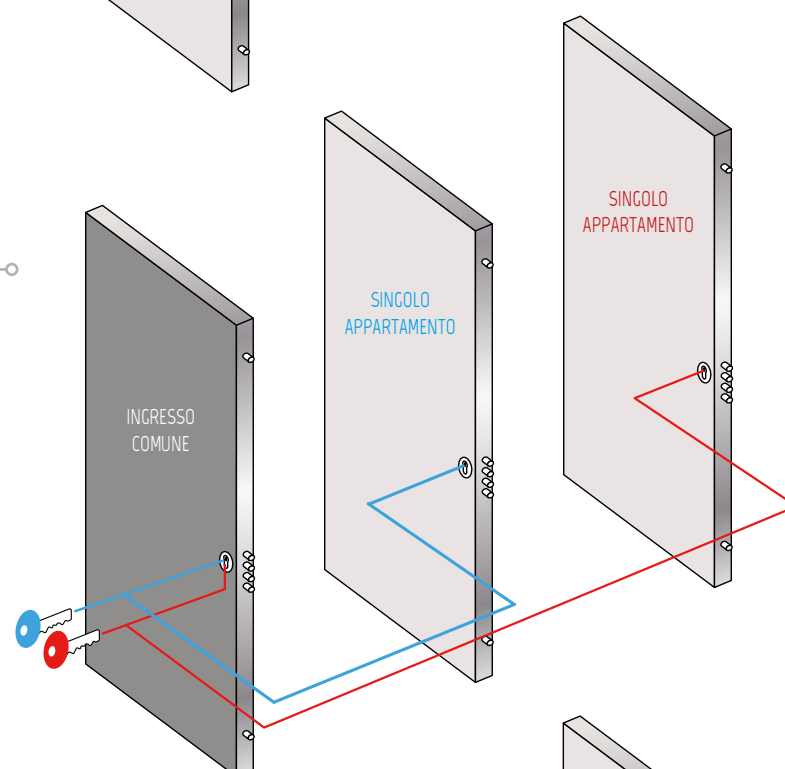

C SISTEMA MK

La mia chiave Passpartout!

FUNZIONE: tutti le porte sono aperte da una chiave personale e da una chiave passpartout.
ESEMPIO: usato in alberghi, uffici e aziende. Utilizzato nel caso in cui una persona ha la necessità di azionare più cilindri dotati di chiavi individuali diverse tra loro.

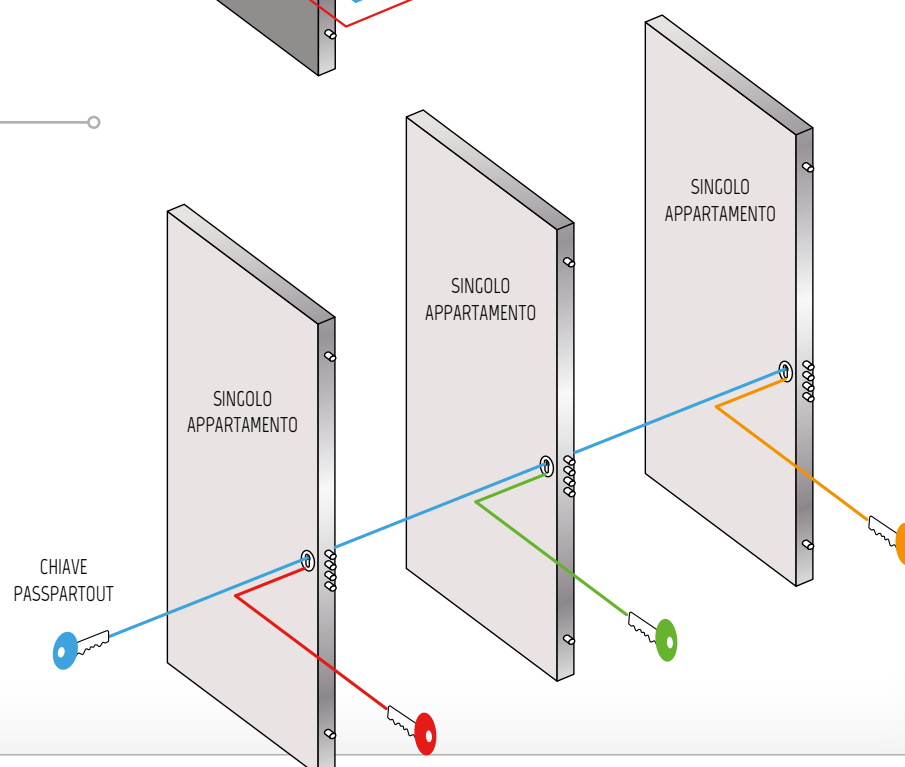



Maniglie

IN

INOX SATINATO

IG

INOX LUCIDO

IL

INOX OTTONE LUCIDO

CS

CROMO SATINATO

CL

CROMO LUCIDO

OL

OTTONE LUCIDO

OS

OTTONE SATINATO

BR

BRONZO GRAFFIATO

AB

ALLUMINIO BRONZATO

PI

INOX PVD SATINATO

PV

OTTONE PVD LUCIDO

FINITURE ACCIAIO INOX

Il termine generico "acciaio Inox" coinvolge molti tipi di lega di acciaio con elevata resistenza alla corrosione. Ha un minimo contenuto di cromo, è quindi consigliato per le zone ad alta salinità.

FINITURE CLASSICHE

La gamma delle finiture Classiche è composta da cromie realizzate con trattamenti molto differenti. Gli ottoni naturali, con il fascino del lucido e la raffinatezza del satinato, sono protetti da verniciatura di protezione che ne mantiene l'aspetto nel tempo. Le cromature, dai toni neutri e uno spiccato tocco di modernità, sono realizzate con trattamenti galvanici che le proteggono dall'usura e dall'ambiente. Il bronzato graffiato è realizzato con la bronzatura spazzolata e protetta da verniciatura trasparente.

FINITURE PVD

Derivato dalle applicazioni aerospaziali, il PVD (Physical Vapour Deposition) è l'unico trattamento finora in grado di offrire un'elevata e durevole protezione superficiale della maniglia al fine di resistere ai graffi e alla corrosione.





M1



M5

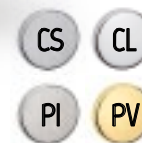

M2



M6



M3

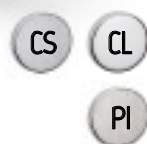

M7



M4

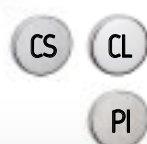

M8





BAT

- CS
- CL
- OL
- OS
- BR
- AB
- PI
- PV



BATQ

- CS
- CL
- PI
- PV



mostrina tonda

- CS
- CL
- OL
- OS
- BR
- AB
- PI
- PV



mostrina quadra

- CS
- CL
- OL



PTF

- CS
- CL
- OL
- OS
- BR
- AB
- PI
- PV



PTF-70

- CS
- CL
- OL
- OS
- BR
- PI
- PV



PTF-i

- IN
- IG



PQF

- CS
- CL
- OL
- PI
- PV



PQF-i

- IN
- IG



PTS

- CS
- CL
- OL
- BR
- AB
- PI
- PV



PQS

- CS
- CL
- OL
- PI
- PV



POV

- CS
- CL
- OL
- OS
- BR
- AB
- PI
- PV



POV-i

- IN
- IG



INOX SATINATO



INOX LUCIDO



INOX OTTONE LUCIDO



CROMO SATINATO



CROMO LUCIDO



OTTONE LUCIDO



OTTONE SATINATO



BRONZO GRAFFIATO



ALLUMINIO BRONZATO



INOX PVD SATINATO



OTTONE PVD LUCIDO



166cm



166 cm

70 cm



50 cm

116 cm

116 cm

BAR05

IN IC IL

BAR03

IN IC IL

BAR04

IN IC IL

66 cm

66 cm

30 cm



46 cm

46 cm

25 cm



BAR01

PV IN IC

BAR07

IN IC

Kit maniglie tondo



INTERNO

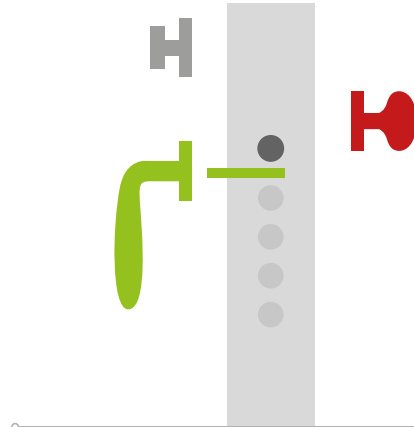

KIT TONDO A
 INTERNO
 pomolino limitatore +
 maniglia interna
 ESTERNO
 pomolo fisso esterno
 posizione a scelta
 (■ non aziona lo scrocco)



ESTERNO



INTERNO

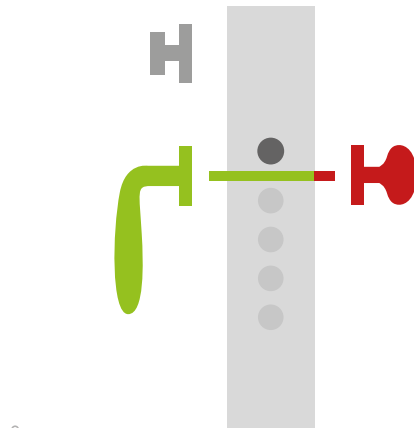

KIT TONDO B
 INTERNO
 pomolino limitatore +
 maniglia interna
 ESTERNO
 pomolo fisso esterno
 con quadro passante
 (■ non aziona lo scrocco)



ESTERNO



INTERNO

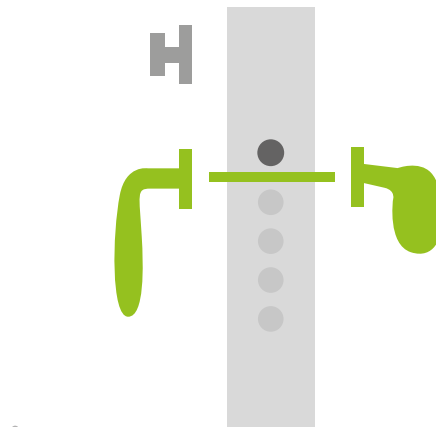

KIT TONDO C
 INTERNO
 pomolino limitatore +
 maniglia interna
 ESTERNO
 pomolo spostato esterno
 (■ aziona lo scrocco)



ESTERNO

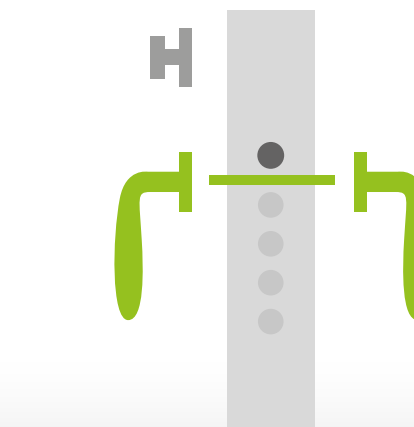

KIT TONDO D
 INTERNO
 pomolino limitatore +
 maniglia interna +
 ESTERNO
 maniglia esterna
 (■ aziona lo scrocco)



ESTERNO

Kit maniglie quadro

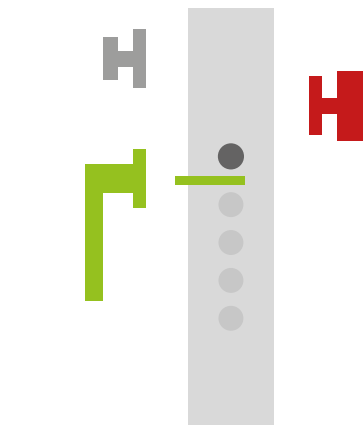

KIT QUADRO A
 INTERNO
 pomolino limitatore +
 maniglia interna
 ESTERNO
 pomolo fisso esterno
 (■ non aziona lo scrocco)

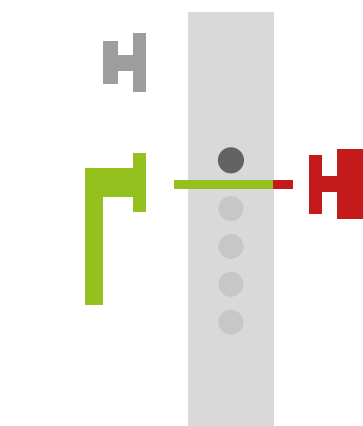

KIT QUADRO B
 INTERNO
 pomolino limitatore +
 maniglia interna
 ESTERNO
 pomolo fisso esterno
 con quadro passante
 (■ non aziona lo scrocco)

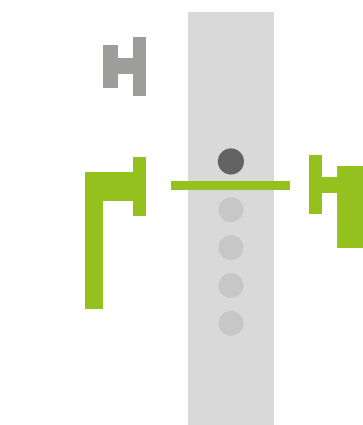

KIT QUADRO C
 INTERNO
 pomolino limitatore +
 maniglia interna
 ESTERNO
 pomolo spostato esterno
 (■ aziona lo scrocco)



INTERNO

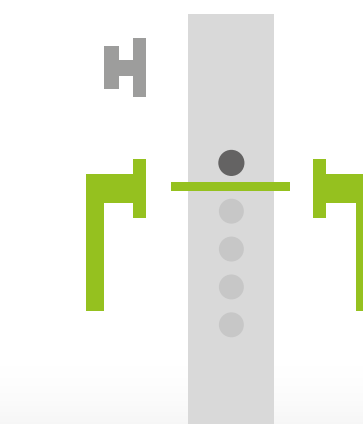

KIT QUADRO D
 INTERNO
 pomolino limitatore +
 maniglia interna
 ESTERNO
 maniglia esterna
 (■ aziona lo scrocco)





Finestrature

Finestrature standard

Finestrature standard realizzate sulla struttura blindata dell'anta, abbinabili a qualsiasi rivestimento liscio (non lavorato)

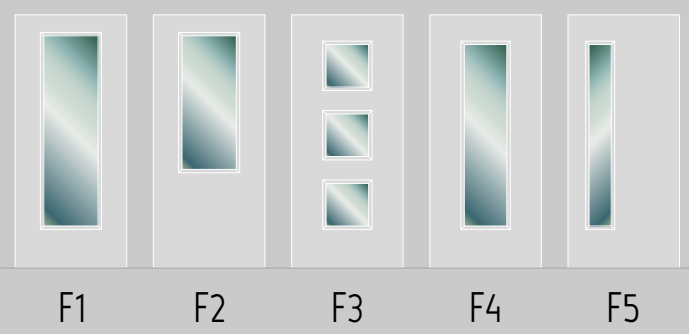

Finestrature su rivestimento

Finestrature realizzate sulla base della tipologia di rivestimento richiesto, l'anta blindata viene adattata alle superfici vetrate richieste. Per la scelta verificare le soluzioni proposte per ogni modello nella sezione rivestimenti.



Vetri

A ANTIVANDALISMO SP=32



B ANTIVANDALISMO SP=42



C ANTISFONDAMENTO SP=42



SEZIONI	5+5 CAMERA 16 3+3	5+5 CAMERA 22 4+4	8+8 CAMERA 16 3+3
SPESSORE	32 mm	42 mm	42 mm
STRUTTURA	CANALINA A BORDO CALDO + CAMERA CON GAS ARGON		
ANTIEFFRAZIONE	P4A (EN 356)	P4A (EN 356)	P6B (EN 356)
TRASMITTANZA	1,00 W/m ² k	1,10 W/m ² k	1,30 W/m ² k
TIPOLOGIA	TRASPARENTE O SATINATO		TRASPARENTE O SABBIAATO

PROVA	CLASSE	DESCRIZIONE
SFERA	P1A	3 impatti della sfera in caduta da 1500 mm
	P2A	3 impatti della sfera in caduta da 3000 mm
	P3A	3 impatti della sfera in caduta da 6000 mm
	P4A	3 impatti della sfera in caduta da 9000 mm
	P5A	9 impatti della sfera in caduta da 1500 mm
Ascia	P6B	30-50 colpi di martello e di ascia
	P7B	51-70 colpi di martello e di ascia
	P8B	>70 colpi di martello e di ascia

CLASSI DI RESISTENZA EN 356

La norma di riferimento per la classificazione della resistenza dei vetri è la EN 356, che stabilisce 8 classi, in ordine crescente di resistenza, le prime 5 classi, si basano sulla prova di caduta di una sfera di acciaio di 4,1 kg, le altre 3 classi si basano su una prova di attacco con ascia.

Montaggio vetri su **ante** (vetri spessore 42 mm)

6+6

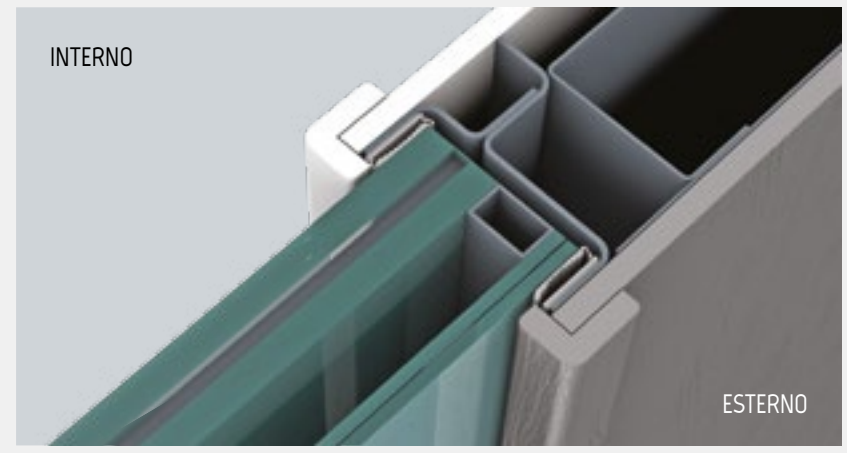
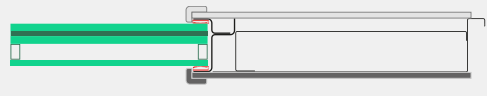

6+6 ALUM

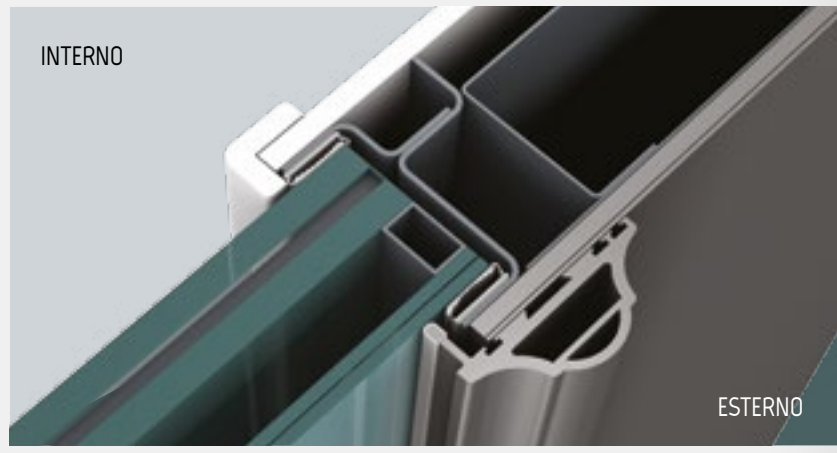
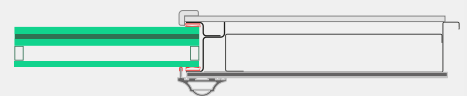

14+14

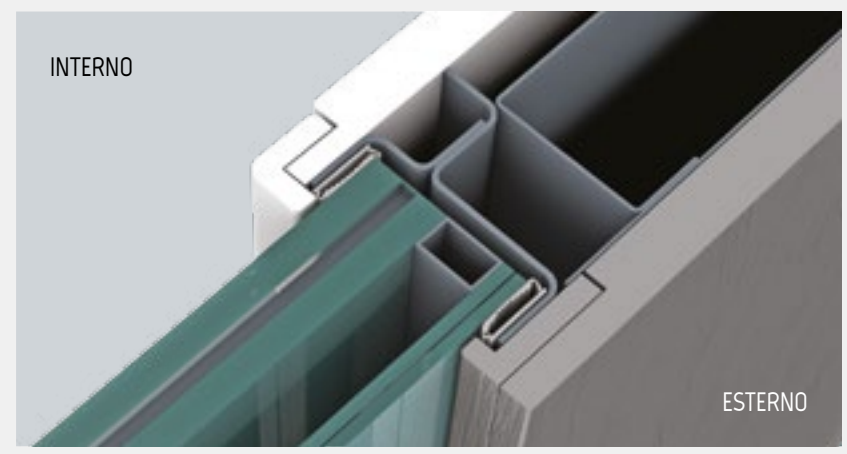
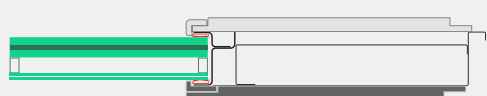

6+12 TECHLINE

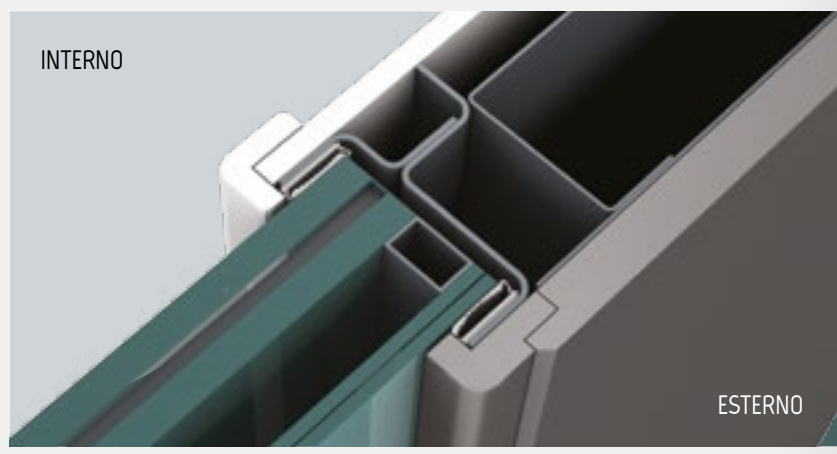
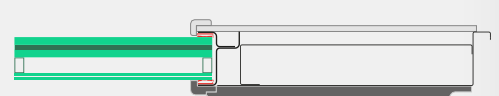

Montaggio vetri su **fianchi fissi e sopraluce**

TELAI S
vetri spessore 42 mm

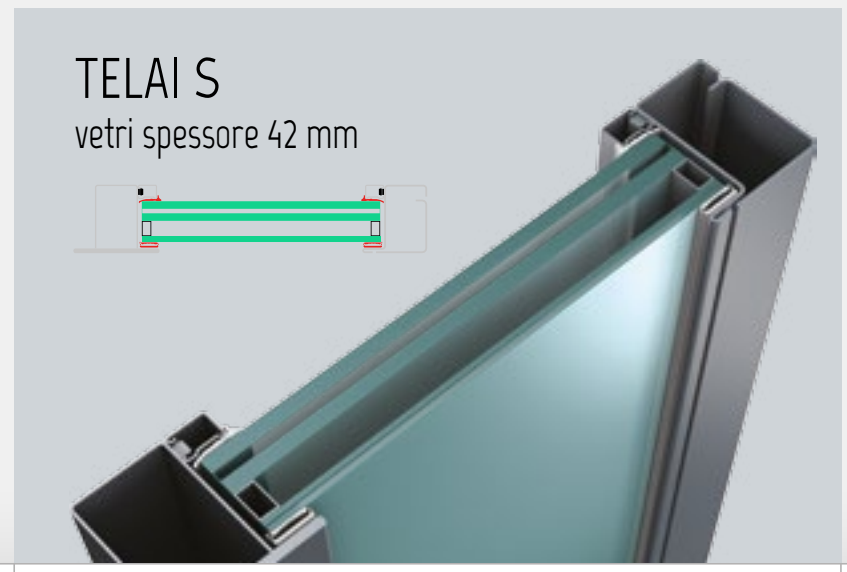

TELAI G - N - C
vetri spessore 32 mm

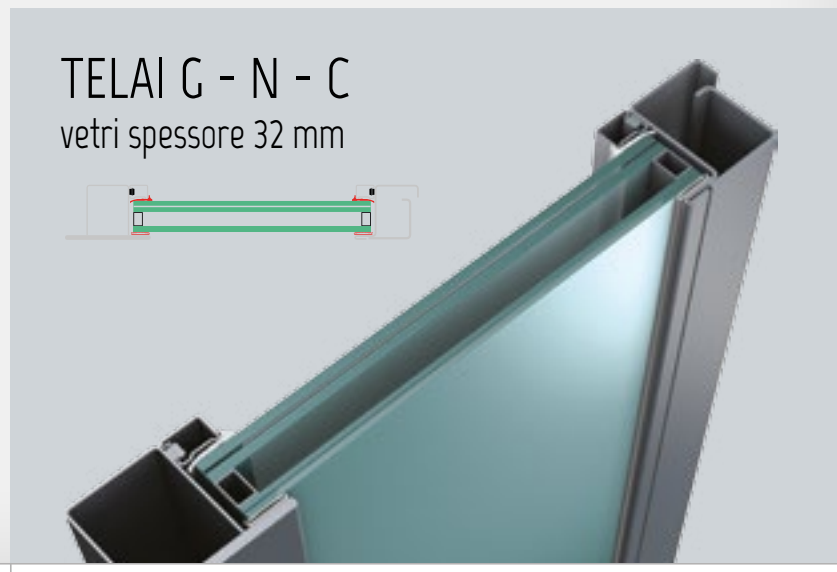
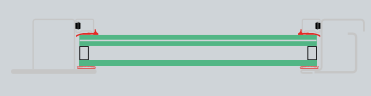



Struttura

Strutture senza sopra luce

Porta singola o doppio battente con fianco fisso



Porta singola o doppio battente con doppio fianco fisso



Strutture con sopra luce

Porta singola o doppio battente con sopra luce quadro o ad arco



Porta singola o doppio battente con fianco fisso e sopra luce quadro o ad arco



Porta singola o doppio battente con doppio fianco fisso e sopra luce quadro o ad arco





Rivestimento
SKY MS4

Copertura telaio

Per qualsiasi tipologia di telaio e di posa sono disponibili profili di copertura.

I profili da applicare in fase di posa, oltre a migliorare l'aspetto estetico della porta sono utili ad aumentare l'isolamento termico migliorando il valore di trasmittanza generale.

Esempio di applicazione profili sia per lato interno che per lato esterno per una versione con sopra luce

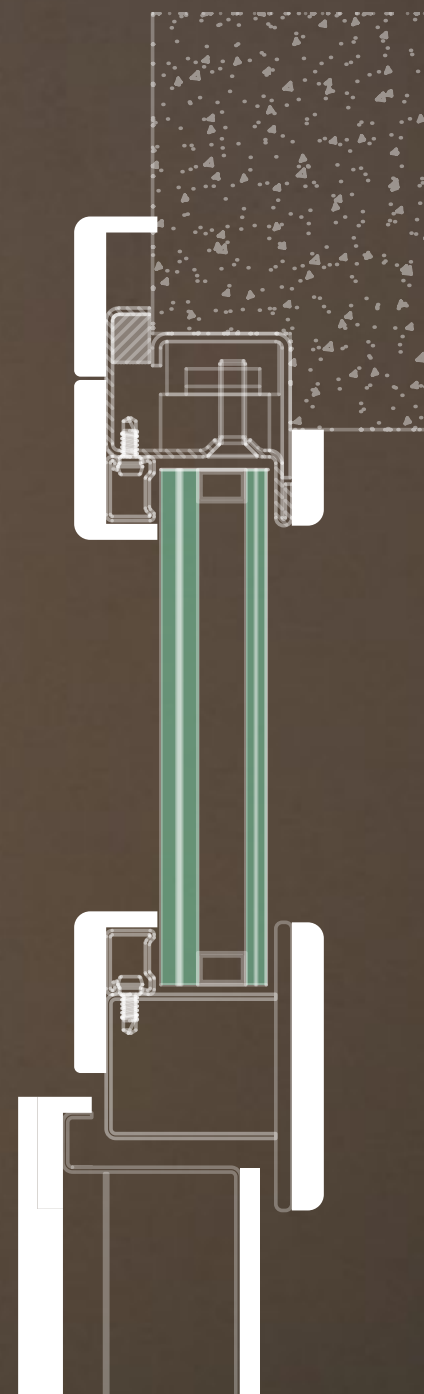



Passate o imbotti per il rivestimento dello spessore della parete con la stessa finitura della porta (per spessori e finiture consultare il listino).

Passate

Passate in legno

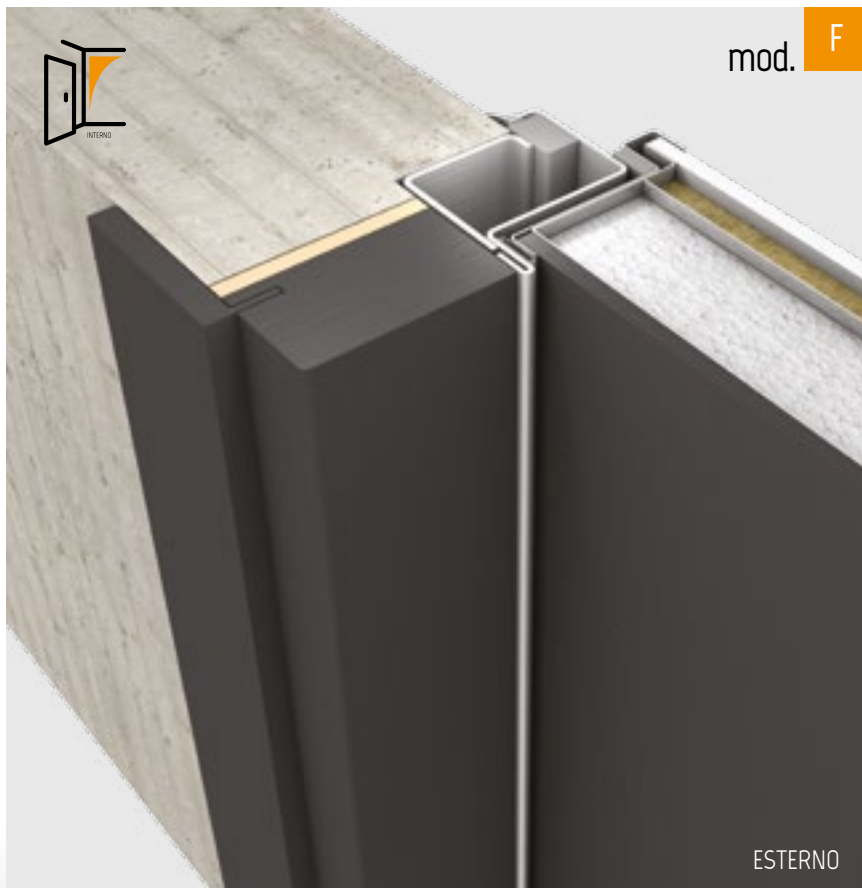
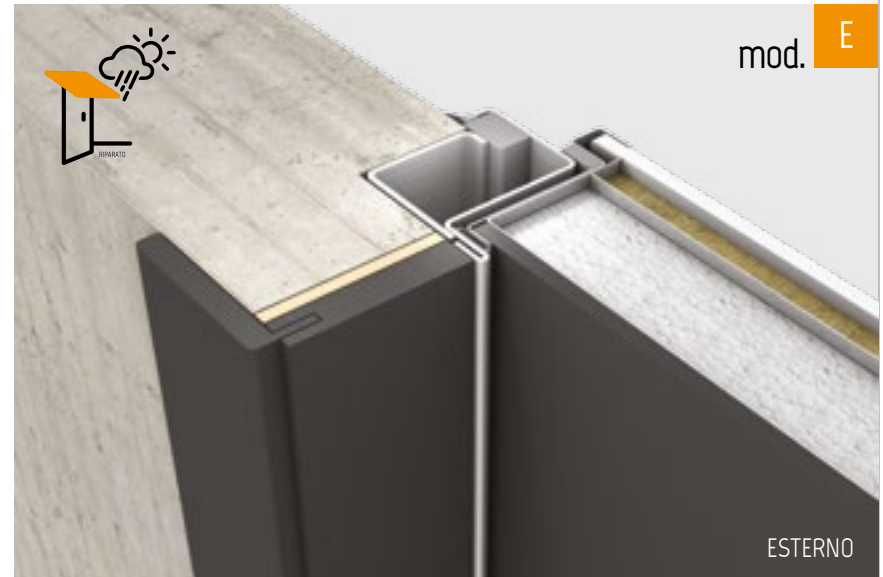

Passate in Alluminio

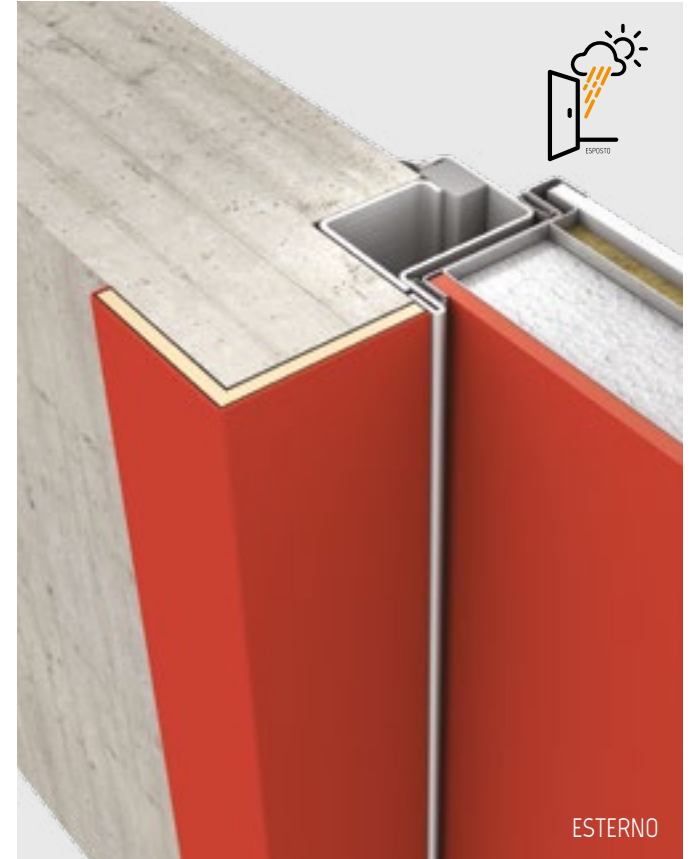

Le passate in alluminio possono avere la stessa finitura o colore del rivestimento del blindato oppure possono essere inox



Passate in PVC

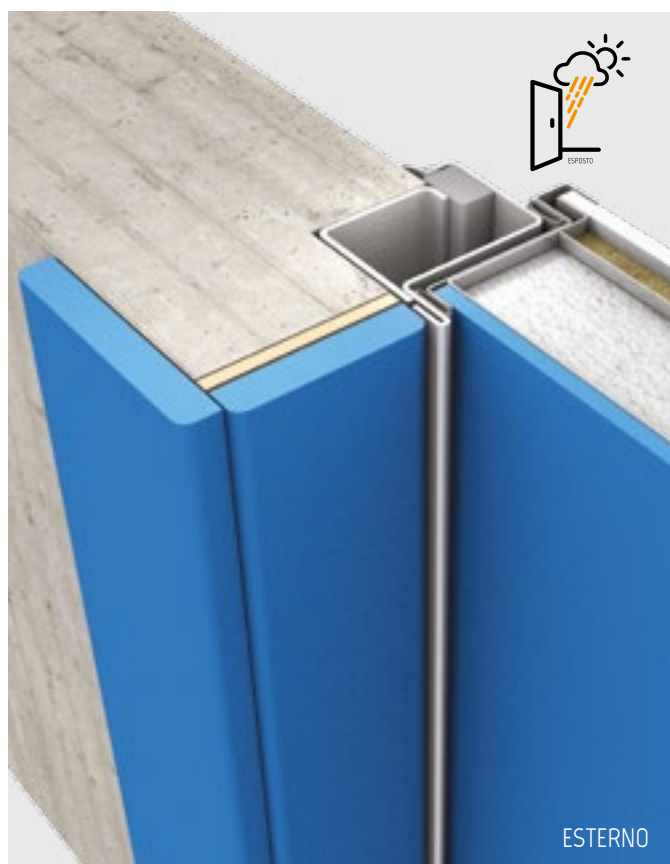

Le passate in PVC sono composte da due profili di copertura realizzati con lo stesso colore del rivestimento e della larghezza desiderata.





Soglie

Tutte le soluzioni proposte sono indicate per migliorare le prestazioni termiche ed acustiche (soglia E - P) o la permeabilità all'acqua (soglia W).
Le soglie A e X sono realizzate per risolvere particolari esigenze di posa



I terminali NO AIR, sono degli elementi di giunzione tra il sistema paraspiffero e la guarnizione sullo stipite della porta; studiati appositamente per una facile installazione garantiscono vantaggiosi risultati nella tenuta all'aria e al rumore.

Soglia E

Soglia in alluminio da fissare a pavimento con doppia guarnizione isolante h = 10 mm. L'altezza del blindato va rilevata dal pavimento. Telaio e controtelaio sono standard.

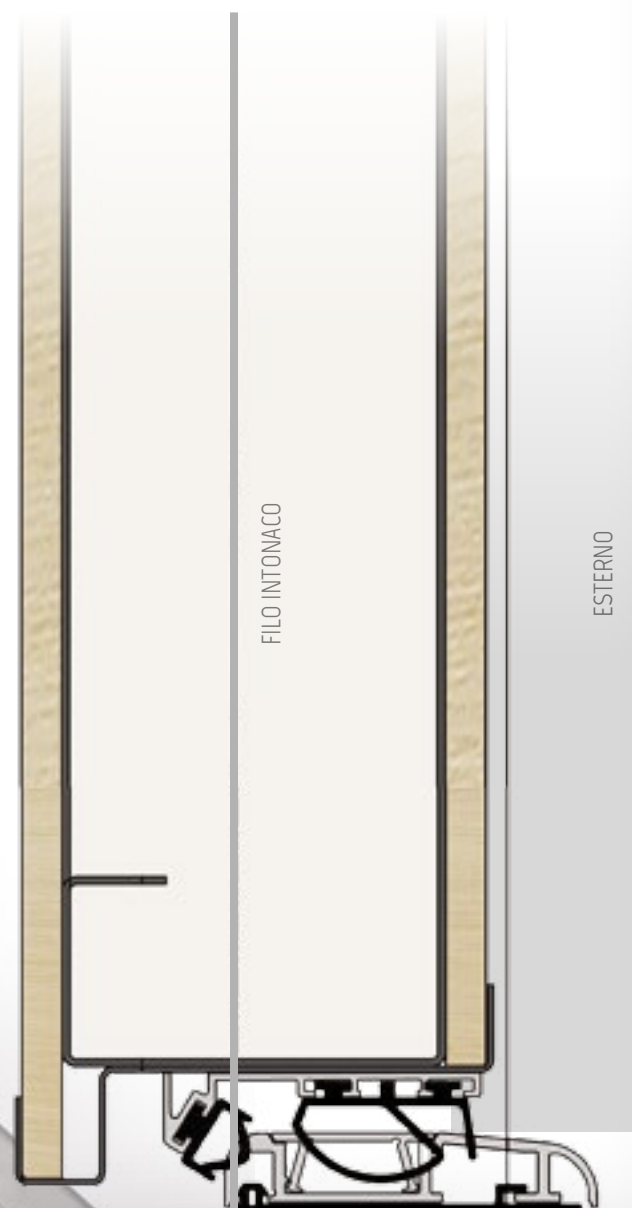

Soglia **P**

Soglia in alluminio da fissare a pavimento h = 15 mm.
L'altezza del blindato va rilevata dal pavimento.
Telaio e controtelaio sono standard.

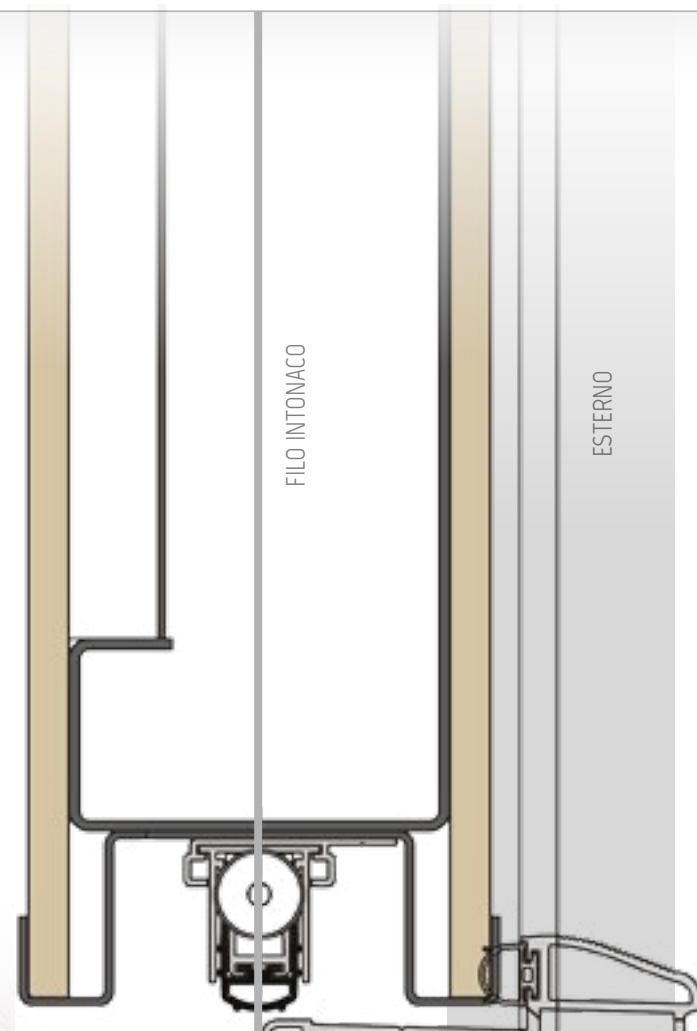

Soglia **W**

Soglia in alluminio da fissare a pavimento h = 10 mm,
specifica per tenuta all'acqua.
L'altezza del blindato va rilevata a partire dal pavimento.
Telaio e controtelaio sono standard.



Soglia X



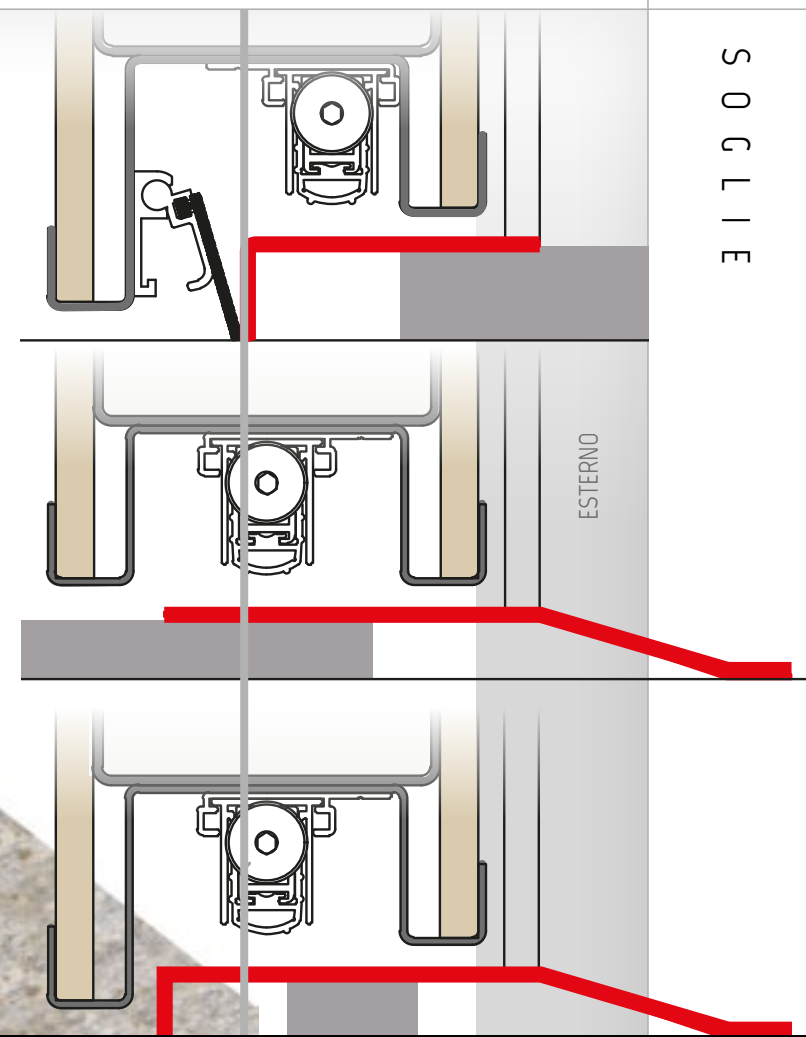





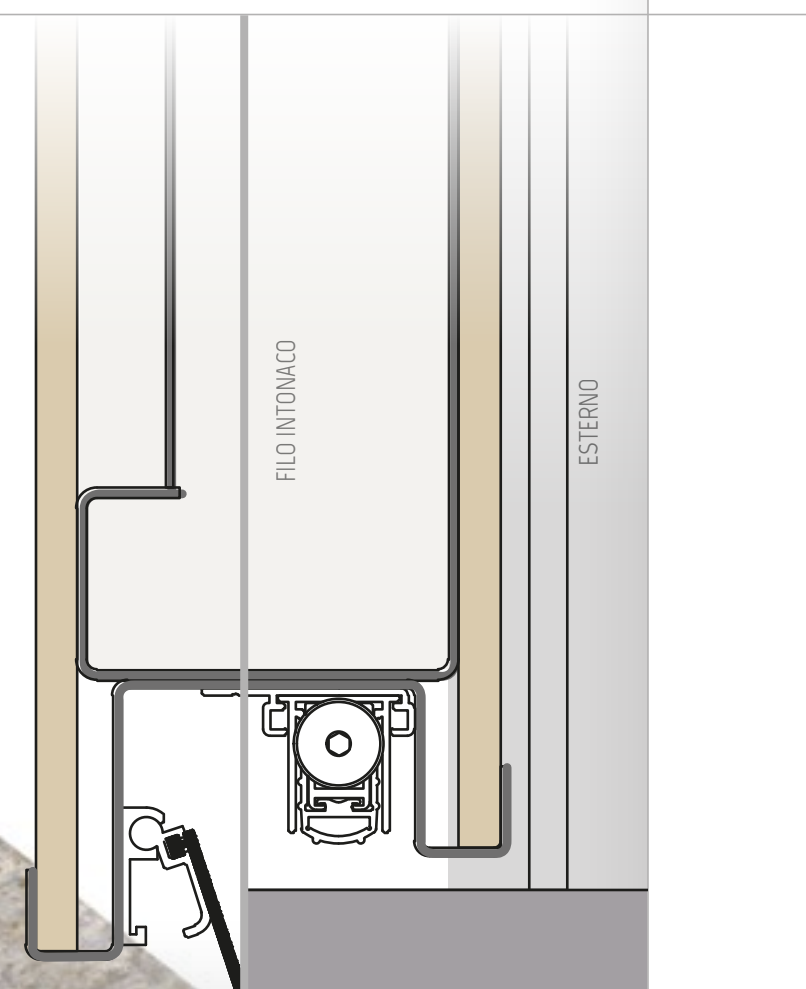



Soglia di raccordo realizzata in acciaio inox applicabile su soglia A, in caso di soglie particolari o per situazioni di pavimenti con altezze differenti tra interno ed esterno.



Soglia A

Il controtelaio (standard) deve essere murato in appoggio sulla soglia ed il blindato viene realizzato prolungando il rivestimento interno e sagomando il telaio sulla soglia. È indispensabile indicare l'altezza della soglia.

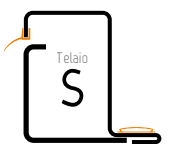
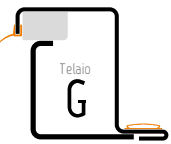
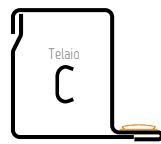
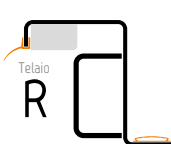
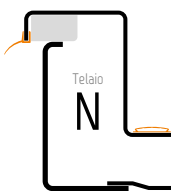

LINEA	MODELLO	  	CLASSE ANTI EFFRAZIONE	TERMICA	ACUSTICA	SERRATURE 																	
						ERACLE	ERACLE DS	ERACLE FL	NETTUNO	SATURNO	ZEUS	SMART	PLUTONE	ARGO	MARTE	ADE	MERCURIO						
EXCLUSIVE	EH4		DA U = 1,6 A U = 1,0 W/m²k	DA 32 db A 42 db			✓	✓	✓														
	EX3												✓	✓	✓	✓	✓	✓	✓				
STYLE	SH4										✓	✓	✓										
	ST7												✓	✓	✓	✓	✓						
	ST10												✓					✓	✓			✓	
PROJECT	PH4										✓	✓	✓										
	PR7												✓	✓	✓	✓	✓						
	PR10												✓					✓	✓				
	SR2						DA U = 2,0 A U = 1,4 W/m²k		DA 29 dB A 36 dB						✓							✓	

PUNTI CHIUSURA MOBILI	LIMITATORE APERTURA	SPIONCINO	PARASPIFFERI	TELAI DISPONIBILI	CERNIERE	FINESTRATURE					ROSTRI FISSI	PROTEZIONE CILINDRO	OPTIONAL	
							SOGLIE	ARIA	VENTO	ACQUA				
11-12	✓	✓	✓		SCOMPARSA	✓	A P E W X	3	3	FINO A 5A	4	DEFENDER CONICO di serie	<ul style="list-style-type: none"> Defender con allarme • Defender rotativo magnetico • Sensore di allarme (antifurto) • Blocca aste elettronico • Serratura con trappola 	
9-10	✓	✓	✓			✓								
11-12	✓	✓	✓		TRADIZIONALI	✓								
7-8	✓	✓	✓			✓								
9-10	✓	✓	✓											✓
11-12	✓	✓	✓											✓
7-8	✓	✓	✓			✓								
9-10	✓	✓	✓											✓
7	✓	✓	✓			✓								✗

Rivestimenti per



Rivestimenti per ambienti esterni

Tutti i rivestimenti per esterno sono realizzati con materiali che garantiscono un'ottima protezione e resistenza dagli agenti atmosferici. La durata nel tempo non si può garantire nel caso di:

- stato di abbandono e scarsa manutenzione;
- pulizia con prodotti chimici aggressivi o abrasivi.

I materiali utilizzati per questo gruppo di rivestimenti riducono al minimo il livello di degrado dovuto all'esposizione diretta ad agenti atmosferici. Sono da considerare naturali e non imputabili a difettosità del prodotto una leggera perdita di brillantezza e una leggera variazione del colore.



Rivestimenti in legno per ambienti esterni riparati

Tutti i rivestimenti in legno per esterno sono trattati con cicli di verniciatura all'acqua garantendo un'ottima protezione dagli agenti atmosferici ed un ridotto impatto ambientale in termini di inquinamento. La durata della finitura dipende dalla protezione da raggi solari, pioggia e forte umidità e dal livello di manutenzione osservato.

blindati Stark



La durata nel tempo non si può garantire nel caso di:







- stato di abbandono e scarsa manutenzione;
 - uso di prodotti chimici diversi da detergenti neutri;
 - ambienti a poca distanza dal mare con forte presenza di salsedine e sabbia;
 - ambienti naturali fortemente aggressivi con temperature tropicali (oltre i 60°C) o polari (inferiore ai -20°C).
- Sono da considerare naturali e non imputabili a difettosità del prodotto una leggera perdita di brillantezza e una leggera variazione del colore.



Rivestimenti per ambienti interni

Tutti i rivestimenti per interno sono realizzati con materiali non idonei all'esposizione ad agenti atmosferici. La durata della finitura dipende dal livello di manutenzione e cura del prodotto. La durata nel tempo non si può garantire nel caso di:

- stato di abbandono e scarsa manutenzione
 - uso di prodotti chimici diversi da detergenti neutri
- Sono da considerare naturali e non imputabili a difettosità del prodotto una leggera perdita di brillantezza e una leggera variazione del colore.

COLLEZIONE	PAG.	AMBIENTE	DURATA GARANZIA	SPESSORE mm	TENUTA UMIDITÀ	
ALUM	118	 ESPOSTO	10	6		Tenuta a livelli alti di umidità e nebbia, consigliato per ambienti con condizioni fortemente aggressivi con presenza di salsedine e sabbia
ALUM LIGHT	126		5	6		Tenuta a livelli alti di umidità e nebbia, con ambienti esterni non direttamente esposti a condizioni di mare con forte presenza di salsedine e sabbia
TECHLINE	128		5	12		
FIBERLINE	136		5	7 - 21		
GLASS	140		5	6		
WOODLINE	146	 RIPARATO	2	21		Tenuta a medi livelli di umidità e nebbia, in ambienti esterni riparati totalmente da portico, balcone o pensilina
SKY	150		2	14		
CROSS	154		2	14		
CORNER	158		2	14		
CLASSIC	164		2	14		
STONE	168		2	14		
RUSTICI	170		2	14		
SURFACE	172		2	6 - 14		
CHROME	178		 INTERNO	2		
CONCEPT	184	2		6 - 14		
RESET	188	2		14		
LIVING	192	2		6 - 12		
EASY	194	2		6		
LAMINATE	196	2		6 - 12		
ASSEMBLY	200	2		20		
RILIEVI	202	2		6		
INTARSI	203	2		6		

CARATTERISTICHE TECNICHE

Supporto in piral con applicazione di lastra
In alluminio frontale da 1,2 mm e retro da 0.6 Mm.

Supporto in mdf con applicazione di lastra
In alluminio frontale da 1,2 mm e retro da 0.6 Mm.

Supporto in hdf rivestito con pellicole in pvc-acrilico

Supporto realizzato con doppio strato di resina rinforzata e schiuma poliuretanic, superficie esterna in gelcoat in grado di resistere agli agenti atmosferici e ai raggi ultravioletti

Vetro temprato extrachiaro retrolaccato

Rivestimenti realizzati interamente in legno massiccio

Rivestimenti pantografati

- In essenza sono realizzati in multistrato con fibre parallele con incollaggio resistente agli agenti atmosferici
 - Laccati sono realizzati in mdf idrofugo
- Con buona resistenza all'acqua e agli agenti atmosferici

Rivestimenti in hpl "high pressure laminate"

Rivestimenti pantografati Incisi su mdf con laccatura opaca

Rivestimenti in mdf impiallacciati in essenza

Rivestimenti in mdf impiallacciati in essenza

Rivestimenti in mdf rivestiti con pellicole in laminatino con laccatura opaca

Rivestimenti in mdf/truciolare impiallacciati in essenza

Rivestimenti in mdf rivestiti con pellicole in laminatino

Rivestimenti con applicazione di profili in legno (Cornici, piattabande, zoccoli)

Rivestimenti con applicazione di profili in legno (Cornici, piattabande, zoccoli)

Rivestimenti in mdf/truciolare impiallacciati in essenza

KIT MANUTENZIONE

Per mantenere in buone condizioni i rivestimenti occorre effettuare una pulizia periodica con detergenti neutri o prodotti specifici.



In particolare per i rivestimenti in legno verniciati si consiglia l'utilizzo del kit di manutenzione Stark da utilizzare per la pulizia periodica. La mancata manutenzione fa decadere le condizioni di garanzia riportate in tabella.

I materiali con cui vengono realizzati i rivestimenti determinano la loro resistenza agli agenti atmosferici. Nella scelta dei rivestimenti, oltre alla componente estetica, bisogna tener conto per il rivestimento esterno della collocazione della porta blindata e del tipo di esposizione, mentre per il rivestimento interno non ci sono limitazioni tecniche.

I disegni tecnici riportati sotto ogni rivestimento indicano la presenza di eventuali variabili strutturali legate allo specifico modello. Nel caso in cui non vengano riportati disegni il rivestimento indicato prevede solamente la versione per anta singola senza possibilità di doppie ante o eventuali finestrate.

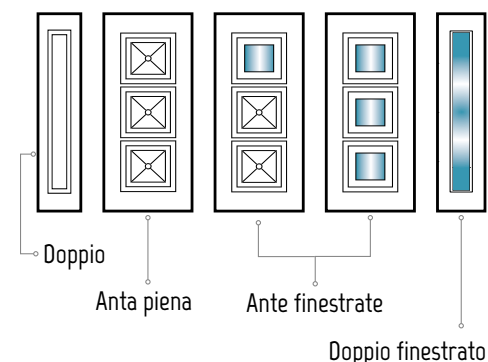

Rivestimenti realizzati con supporto in PIRAL con applicazione di lastra in alluminio frontale da 1,2 mm e retro da 0.6 mm.

AMBIENTE



UMIDITÀ



GARANZIA



SPESSORE



AC6



Alum

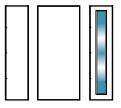

A00

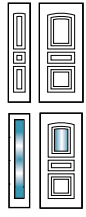

AC1

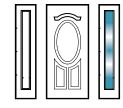

AC2

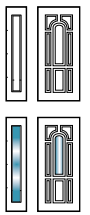

AC3

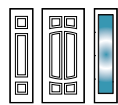

AC4

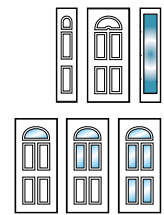

AC5





AC6

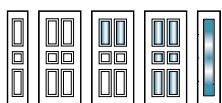

AC7

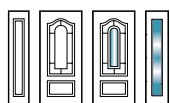

AC8

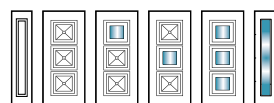

AC9

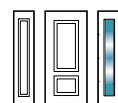

AC10

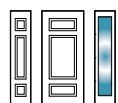

AC11

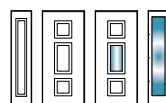

AC12

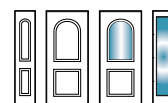

AC13





AD1

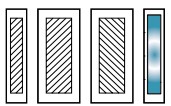

AD2

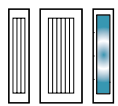

AD3

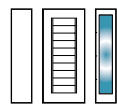

AD4

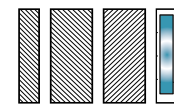

AS4

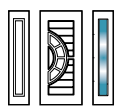

AS5

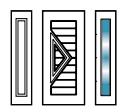

AS6

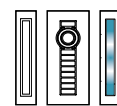

AS7

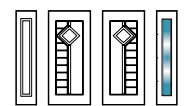



AF1



AF2

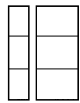

AF3

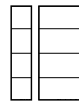

AF4



AF1-a*



AF2-a*

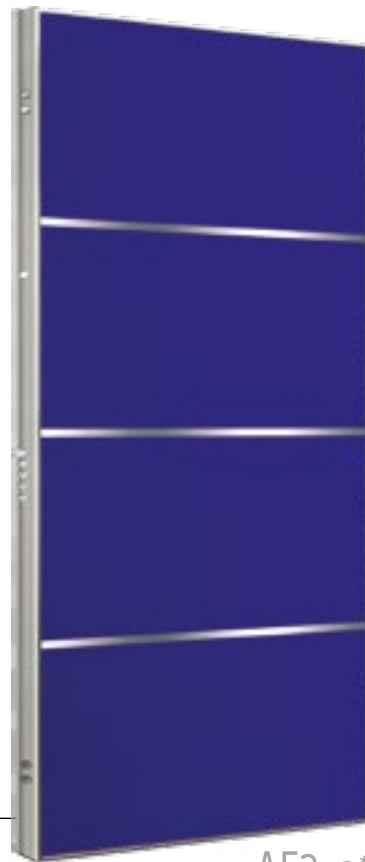
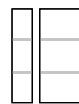

AF3-a*

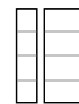

AF4-a*

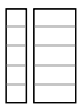



AF5

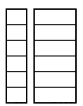

AF6

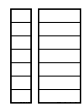

AF7

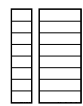

AF8

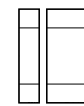

AF5-a*



AF6-a*



AF7-a*



AF8-a*

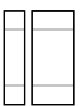



AF9*

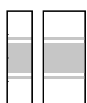

AF10-a*

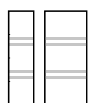

AF10

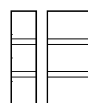

AF11-a*

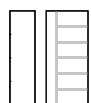

AF11

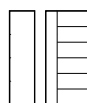

AF12*

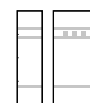

Le tinte sono puramente indicative e non possono rappresentare oggetto di confronto con la finitura della porta

Tinte RAL

Lastra esterna in alluminio laccata con vernici poliesteri polimerizzata al forno a 200°. È possibile realizzare qualsiasi colore RAL.

Pellicole PVC

Lastra esterna in alluminio rivestita con pellicole in PVC disponibile in tutte le finiture del catalogo.

Effetto LEGNO

Lastra esterna in alluminio con effetto legno: un procedimento che utilizza una tecnologia basata sul processo fisico della sublimazione in cui gli speciali inchiostri vengono trasferiti mediante combinazione di calore e pressione.

Particolari lavorazioni dei rivestimenti per tipologia



Particolari rivestimenti AS

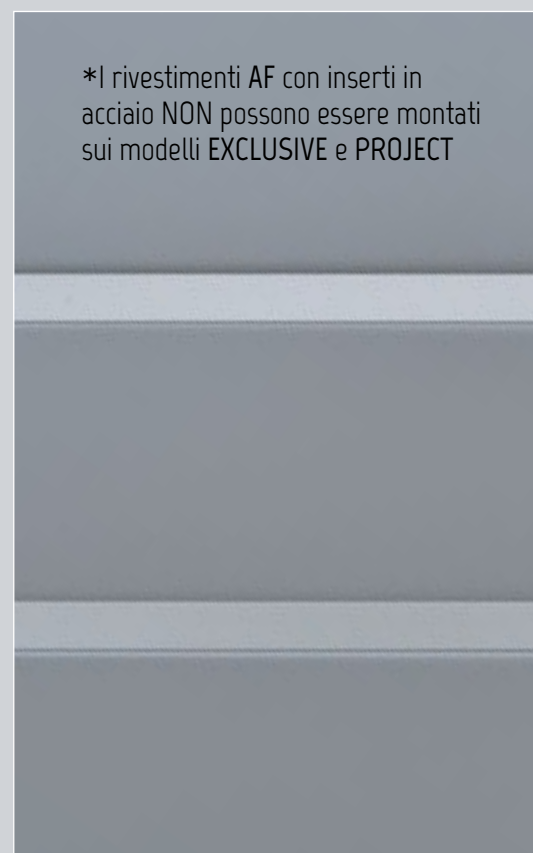

*I rivestimenti AF con inserti in acciaio NON possono essere montati sui modelli EXCLUSIVE e PROJECT

Particolare rivestimenti AC

Particolare rivestimenti AF

Supporto in mdf con
applicazione di lastra
in alluminio frontale da
1,2 mm e retro da 0.6 mm

AMBIENTE



ESPOSTO

UMIDITÀ



GARANZIA



5
ANNI

SPESSORE



6



MD3

Alum-light

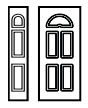

MD1

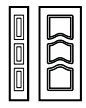

MD2

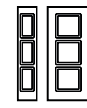

MD4

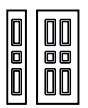

MD5

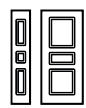

MD6



MD7



Supporto in HDF rivestito
con pellicole in pvc-acrilico

A M B I E N T E

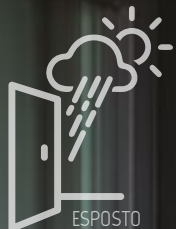

U M I D I T À



C A R A N Z I A



S P E S S O R E



Z80



Techline



PV3

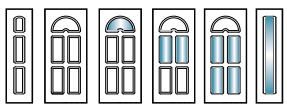

PV4

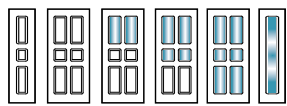

PV7

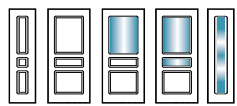

PV8

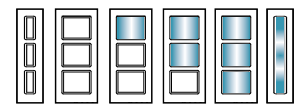

PV9

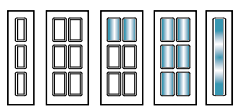

PV11

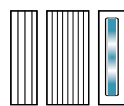

PV12

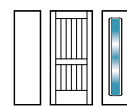

PV13

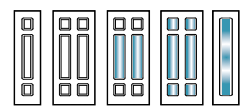



PV15

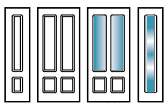

PV16

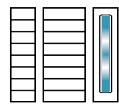

PV20

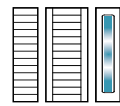

PV21

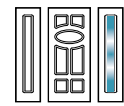

PV22

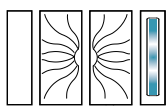

PV23

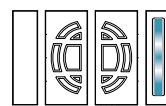

PV24

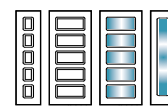

PV25

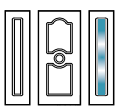



PV26

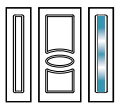

PV28

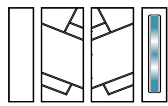

PV32

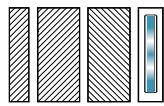

PV34

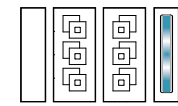

Z07

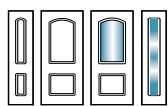

Z14

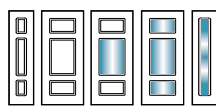

Z22

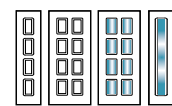

Z80

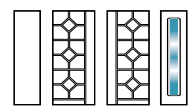



Z85

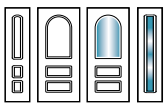

Z113

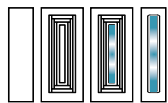

Z118

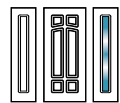

Z158

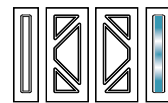

Z173

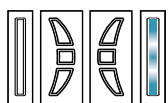

Z177

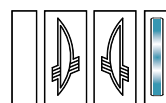

Z180

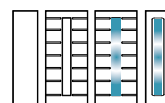

Z183

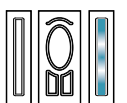



Z190

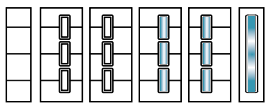

Z192

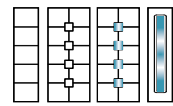

Z194

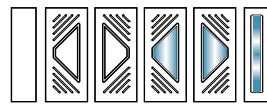

Z197

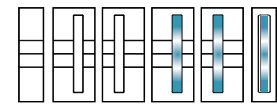

Z200

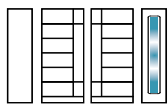

Z300

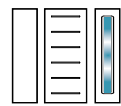

Z308

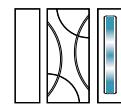

Z318

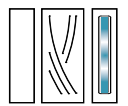



Z350



Z354

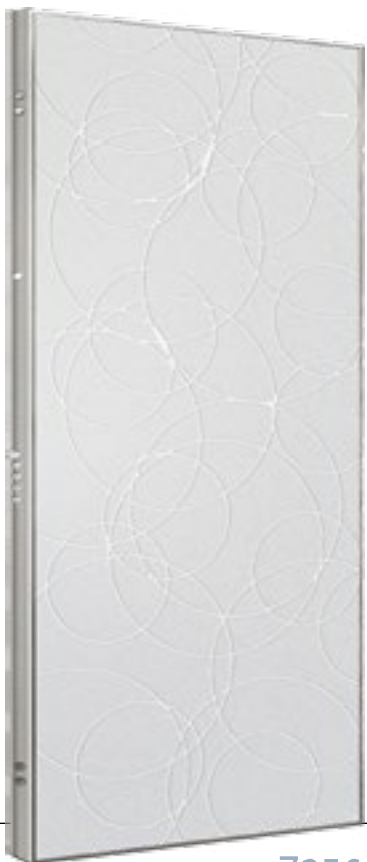
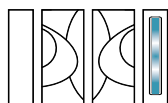

Z356

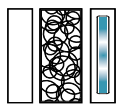

Z357

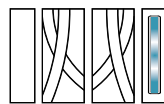

Pellicole TECHLINE

Supporto in HDF rivestito con pellicole in PVC
in tutte le finiture del catalogo Techline

Le tinte sono puramente indicative e non possono
rappresentare oggetto di confronto con la finitura della porta.

Particolari lavorazioni dei rivestimenti per tipologia

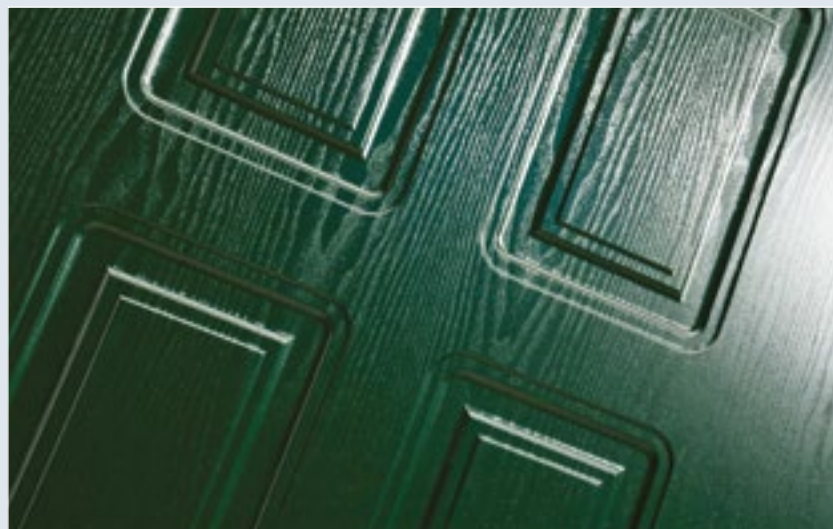
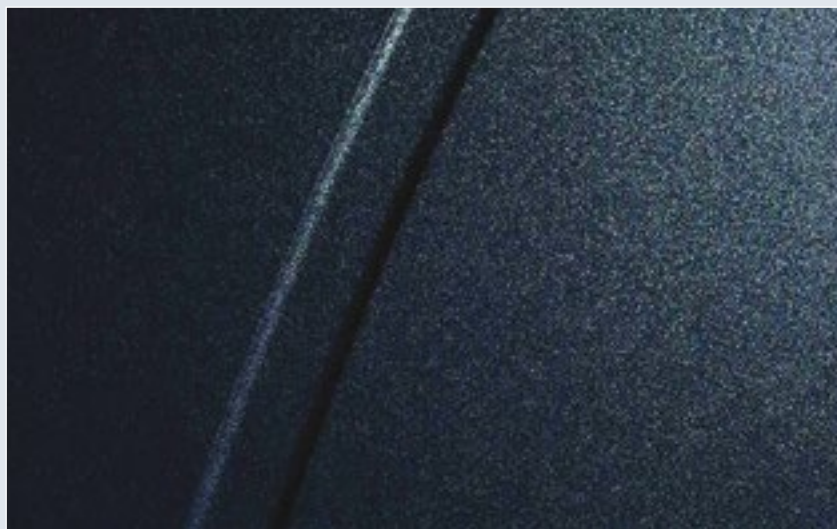
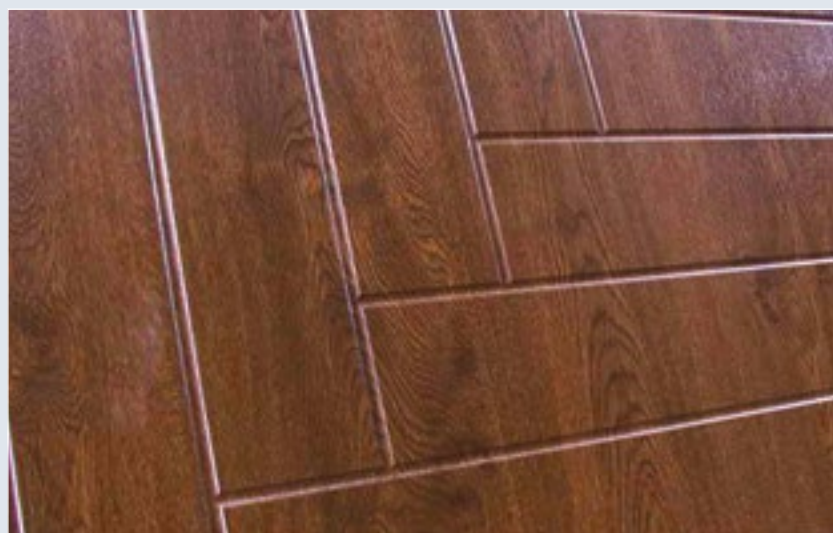
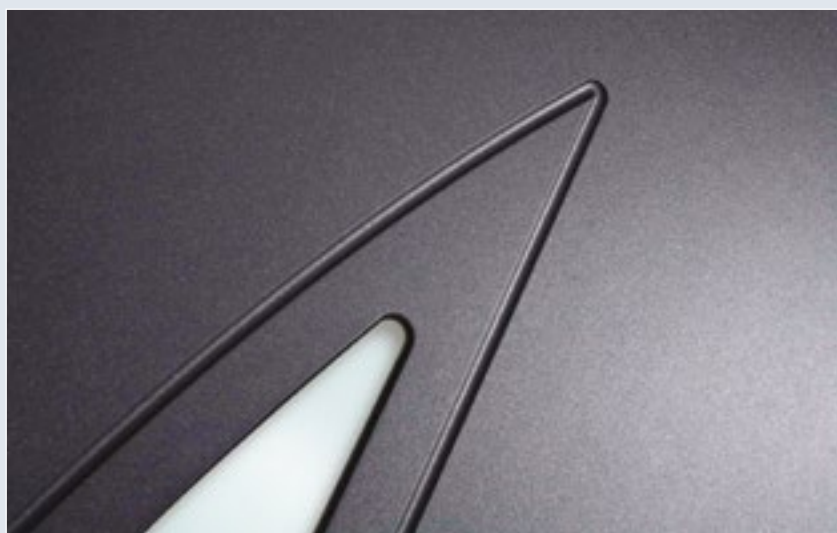
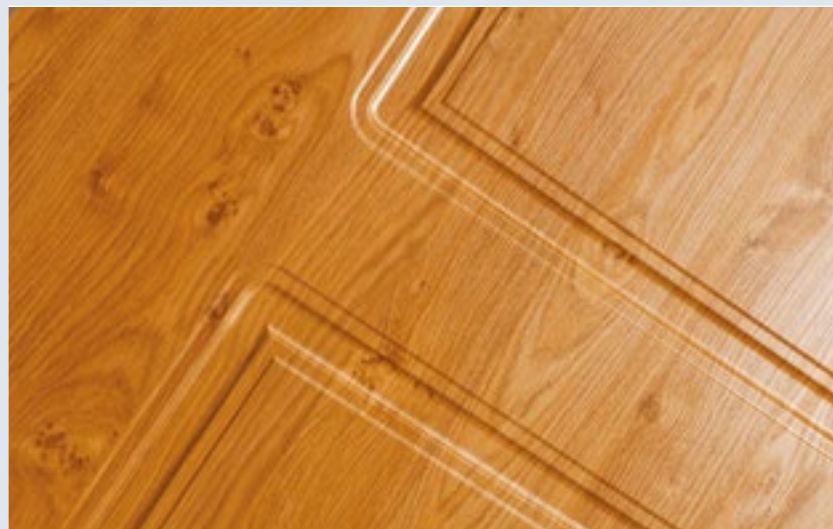
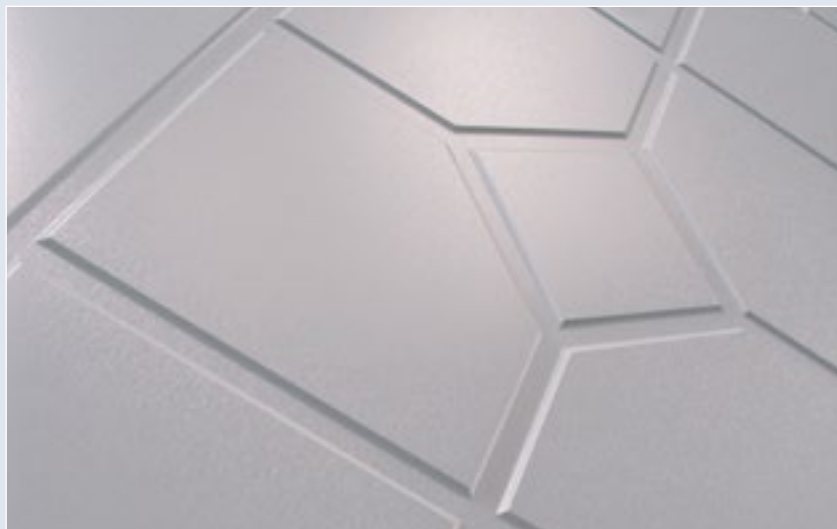

Dettaglio rivestimenti con pellicola Techline tinta unita

Dettaglio rivestimenti con pellicola Techline effetto legno

Supporto realizzato con doppio strato di resina rinforzata e schiuma poliuretanicca.

AMBIENTE



ESPOSTO

UMIDITÀ



GARANZIA



SPESSORE



KN9
effetto legno

Fiberline

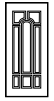

KN1
effetto legno



KN2
effetto legno



KN3
effetto legno

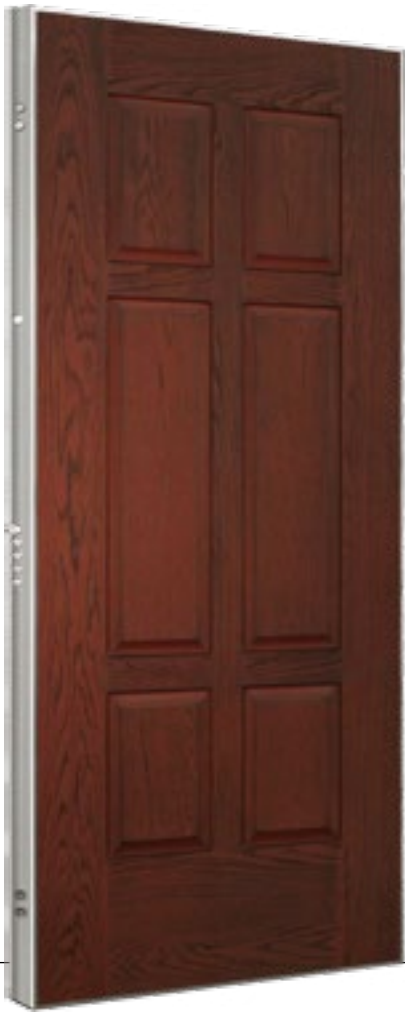

KN4
effetto legno

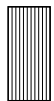

KN5
effetto legno

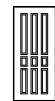

KN6
effetto legno

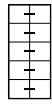

KN7
effetto legno



KN8
effetto legno



KN10
effetto legno



KN11
effetto pietra

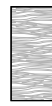

KN12
effetto legno



KN13
effetto legno



Particolare rivestimento effetto legno



Particolare rivestimento effetto pietra

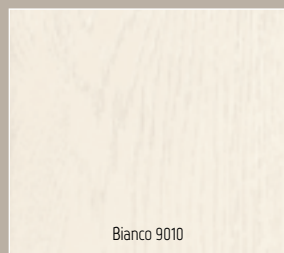

Bianco 9010

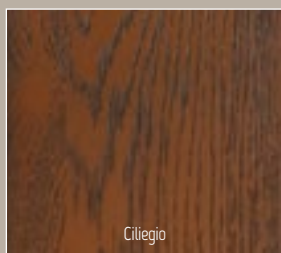

Ciliegio

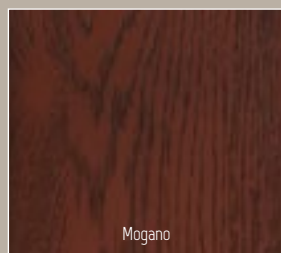

Mogano

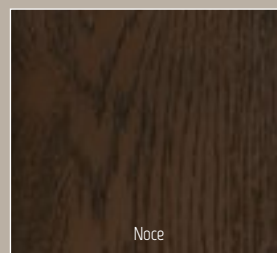

Noce

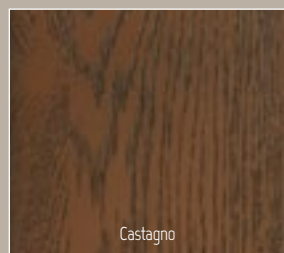

Castagno

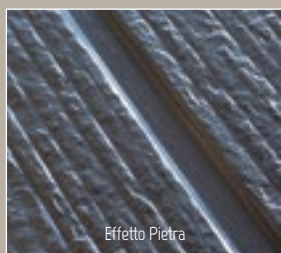

Effetto Pietra

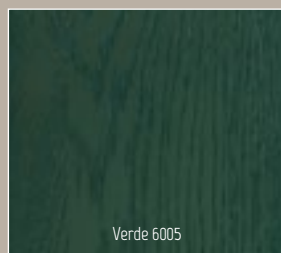

Verde 6005



Verde 6009

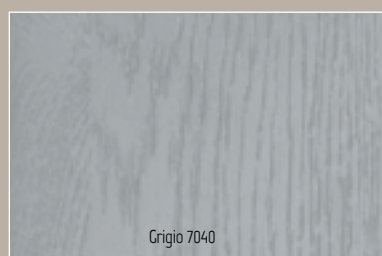
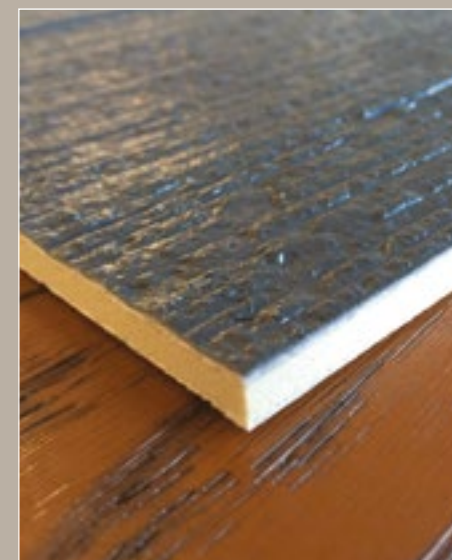

Grigio 7040



Grigio 7016

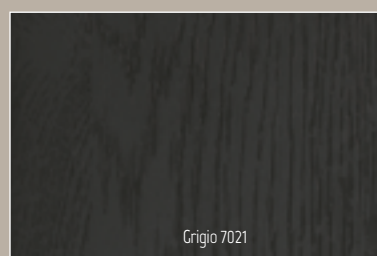

Grigio 7021

Le tinte sono puramente indicative e non possono rappresentare oggetto di confronto con la finitura della porta

Finiture disponibili

GL-s1

Vetro temprato lucido extrachiario retrolaccato con disegno effetto sabbiano (decoro in positivo o in negativo).

AMBIENTE



UMIDITÀ



GARANZIA



SPESORE

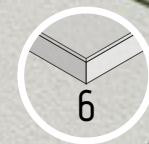

Glass-s

Rivestimenti disponibili solo su lato esterno e solo con maniglione



GL-s1



GL-s2



GL-s3



GL-s4



GL-s5

Non disponibili in versione finestrata e per porte doppie



GS-s1



GS-s2



GS-s3



GS-s4



GS-s5

Le tinte sono puramente indicative e non possono rappresentare oggetto di confronto con la finitura della porta.

GL-b1

Vetro temprato lucido o satinato
extrachiario retrolaccato a due
colori (grigio alluminio e colore
da catalogo)

A M B I E N T E



U M I D I T À



G A R A N Z I A



S P E S S O R E

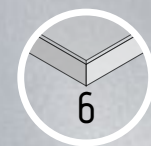

Glass-b

Versione lucida



GL-b2



GL-b3

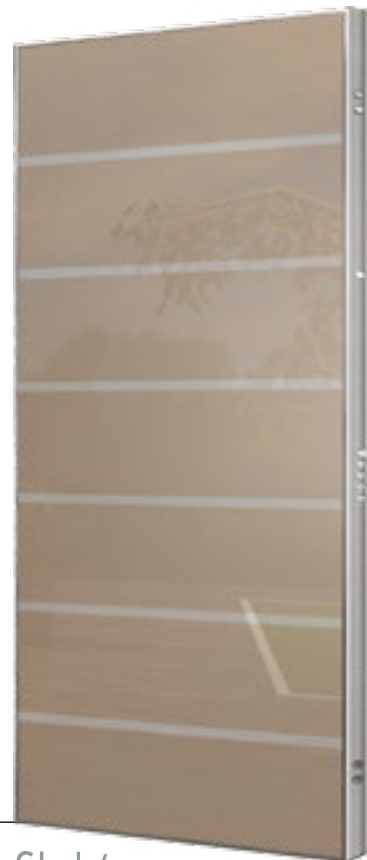

GL-b4



GL-b5

Non disponibili in versione finestrata e per porte doppie

Versione satinata



GA-b2



GA-b3

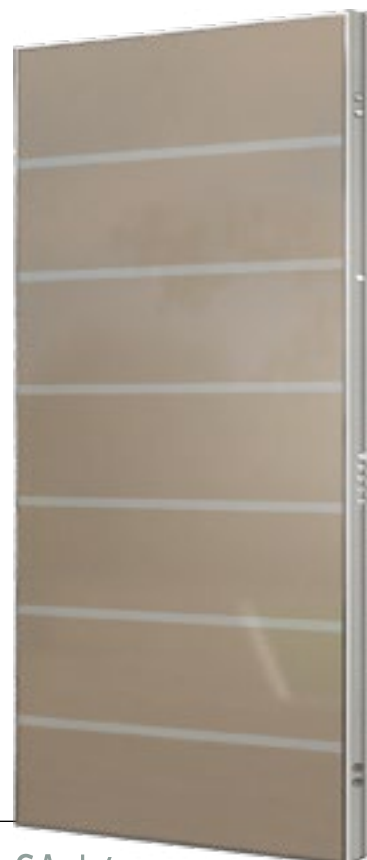

GA-b4



GA-b5



GL-i1

Vetro temprato
lucido extrachiaro
retrolaccato con
decori incisi

A M B I E N T E



U M I D I T À



C A R A N Z I A



S P E S S O R E



Class-i

Rivestimenti disponibili solo su lato esterno e solo con maniglione



GL-i2



GL-i3

Non disponibili in versione finestrata e per porte doppie



GL-i4



GL-i5



GL
vetro lucido



CA
vetro satinato



Finiture disponibili

Le tinte sono puramente indicative e non possono rappresentare oggetto di confronto.

Rivestimenti
realizzati
interamente in
legno massiccio.

AMBIENTE



UMIDITÀ



CARANZIA



SPESSORE



MC16

Woodline

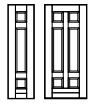

MC1

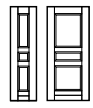

MC3

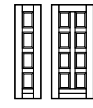

MC4

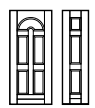

MC6

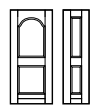

MC10

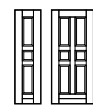

MC11



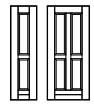

MC12

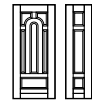

MC13

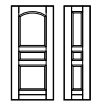

MC14

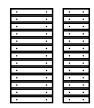

MC15

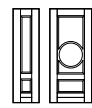

MC17

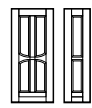

MC18

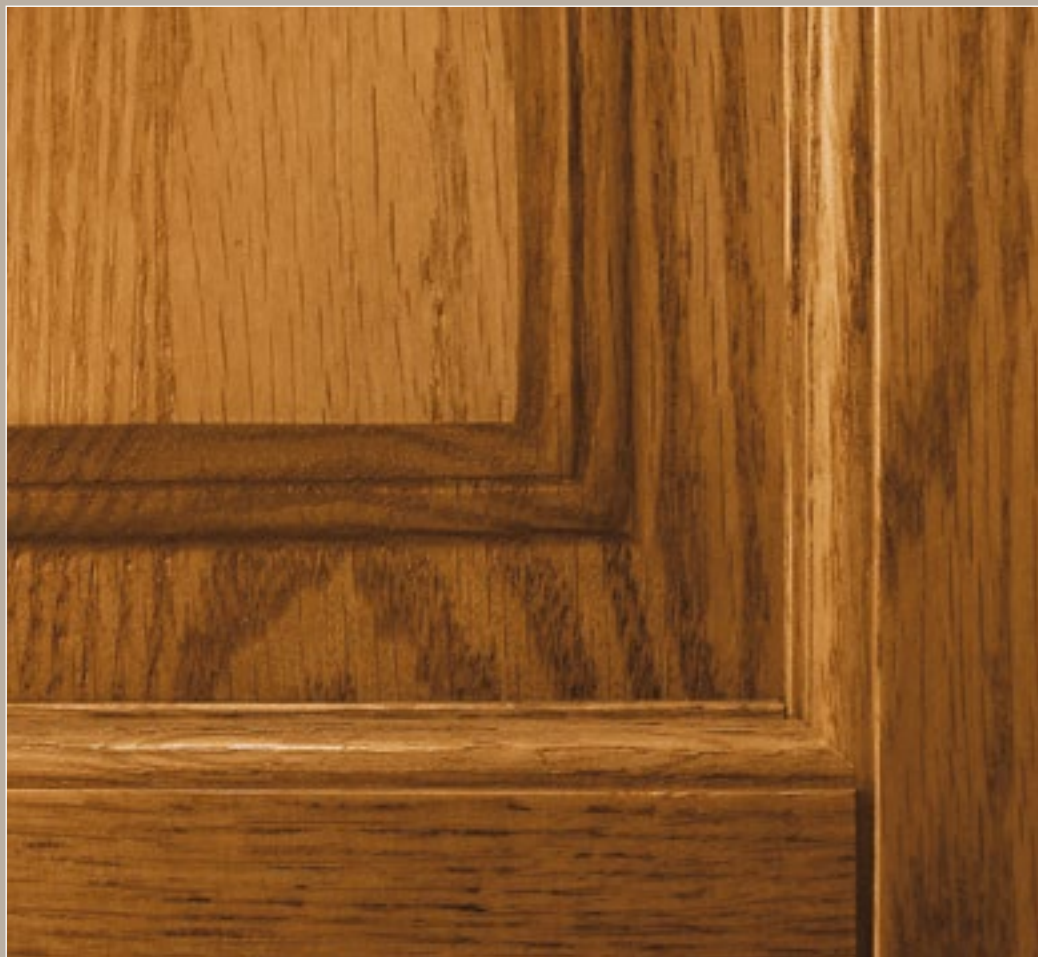

Hemlock Caffè

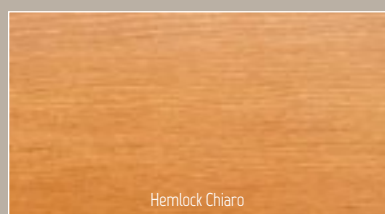

Hemlock Chiaro

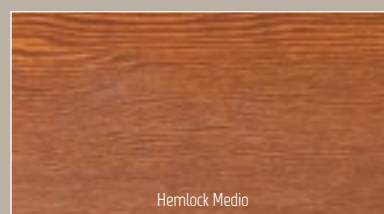

Hemlock Medio

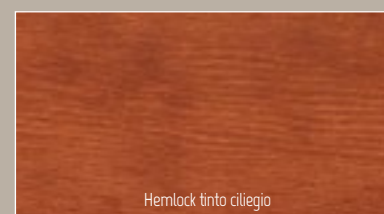

Hemlock tinto ciliegio

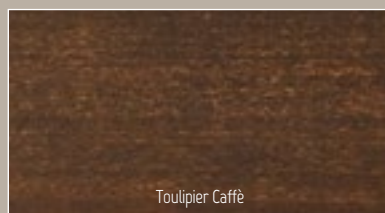

Toulpier Caffè

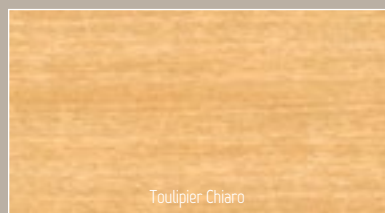

Toulpier Chiaro

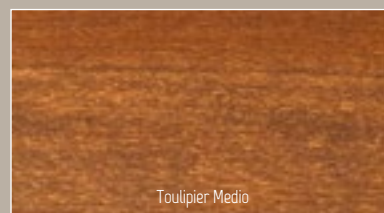

Toulpier Medio

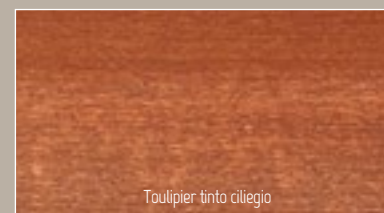

Toulpier tinto ciliegio

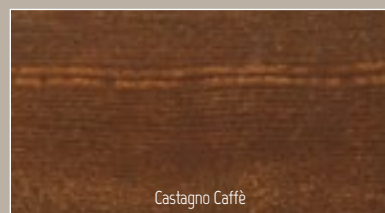

Castagno Caffè

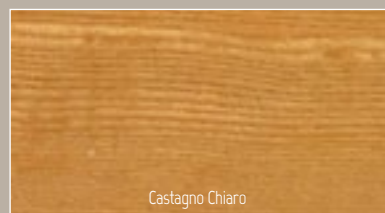

Castagno Chiaro

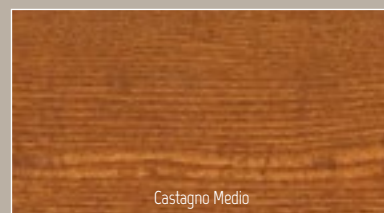

Castagno Medio

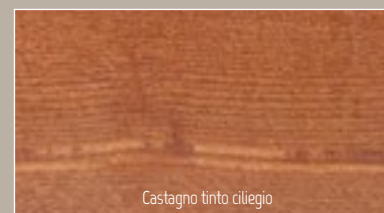

Castagno tinto ciliegio

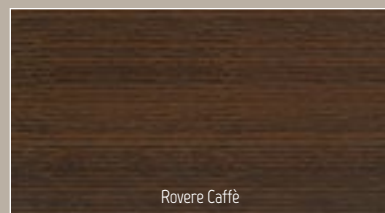

Rovere Caffè

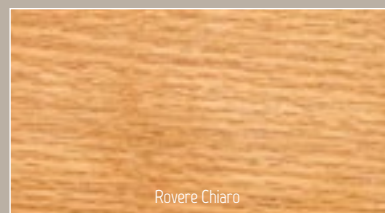

Rovere Chiaro

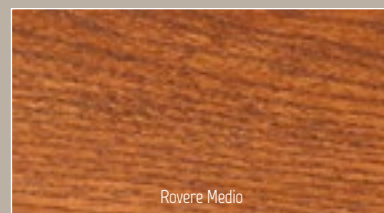

Rovere Medio

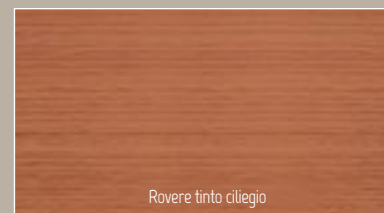

Rovere tinto ciliegio

Rivestimenti
pantografati con
inserti in acciaio inox

A
M
B
I
E
N
T
E



U
M
I
D
I
T
À



C
A
R
A
N
Z
I
A



S
P
E
S
S
O
R
E

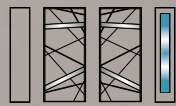

MS16

Sky

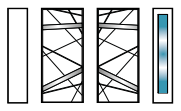

MS16

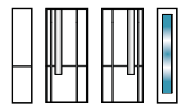

MS15

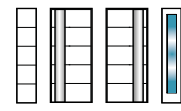

MS14

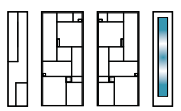

MS08

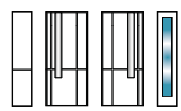

MS15

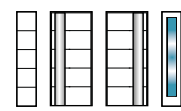

MS14



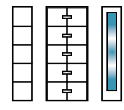

MS04

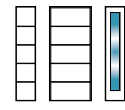

MS03

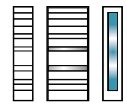

MS06

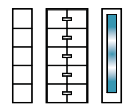

MS04

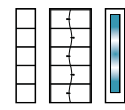

MS10

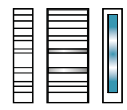

MS6



okume chiaro	okume medio	okume tinto ciliegio	okume tinto mogano	okume caffè	okume moka
rovere chiaro	rovere medio verticale	rovere tinto ciliegio verticale	rovere cognac verticale	rovere caffè verticale	rovere moka verticale
rovere chiaro	rovere medio orizzontale	rovere tinto ciliegio orizzontale	rovere cognac orizzontale	rovere caffè orizzontale	rovere moka orizzontale
frassino chiaro	frassino medio	frassino tinto ciliegio	frassino cognac	frassino caffè	frassino moka
tanganika chiaro	rovere spazzolato laccato avorio	frassino spazzolato laccato avorio	laccato avorio	laccato avorio texturizzato	laccato 9010
tanganika tinto ciliegio	rovere spazzolato laccato bianco	frassino spazzolato laccato bianco	laccato bianco	laccato bianco texturizzato	9010 texturizzato
tanganika medio	rovere spazzolato laccato grigio	frassino spazzolato laccato grigio	laccato grigio	laccato grigio texturizzato	laccato 6005
tanganika scuro	rovere spazzolato laccato tortora	frassino spazzolato laccato tortora	laccato tortora	laccato tortora texturizzato	6005 texturizzato



Versione laccata disponibile in tutte le tinte RAL.
Le tinte sono puramente indicative e non possono rappresentare oggetto di confronto con la finitura della porta.

Rivestimenti
pantografati.

AMBIENTE



UMIDITÀ



CARANZIA



SPESSORE



V19

Cross

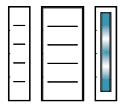

V5

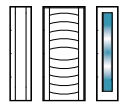

V6

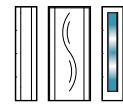

V8

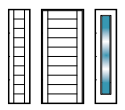

V9

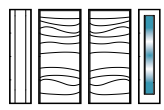

V11

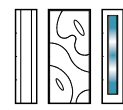

V13



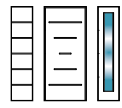

V15

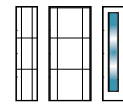

V16

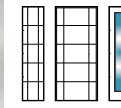

V17

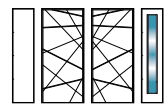

V18

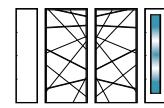

V18

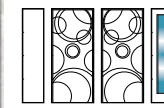

V19



okume chiaro	okume medio	okume tinto ciliegio	okume tinto mogano	okume caffè	okume moka
rovere chiaro	rovere medio verticale	rovere tinto ciliegio verticale	rovere cognac verticale	rovere caffè verticale	rovere moka verticale
rovere chiaro	rovere medio orizzontale	rovere tinto ciliegio orizzontale	rovere cognac orizzontale	rovere caffè orizzontale	rovere moka orizzontale
frassino chiaro	frassino medio	frassino tinto ciliegio	frassino cognac	frassino caffè	frassino moka
tanganika chiaro	rovere spazzolato laccato avorio	frassino spazzolato laccato avorio	laccato avorio	laccato avorio texturizzato	laccato 9010
tanganika tinto ciliegio	rovere spazzolato laccato bianco	frassino spazzolato laccato bianco	laccato bianco	laccato bianco texturizzato	9010 texturizzato
tanganika medio	rovere spazzolato laccato grigio	frassino spazzolato laccato grigio	laccato grigio	laccato grigio texturizzato	laccato 6005
tanganika scuro	rovere spazzolato laccato tortora	frassino spazzolato laccato tortora	laccato tortora	laccato tortora texturizzato	6005 texturizzato



Versione laccata disponibile in tutte le tinte RAL.

Le tinte sono puramente indicative e non possono rappresentare oggetto di confronto con la finitura della porta.

Rivestimenti pantografati.

AMBIENTE



R3



UMIDITÀ



CARANZIA



SPESSORE



Corner



R1

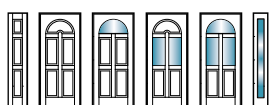

R2



R4

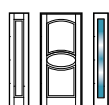

R5



R6



R7



R8



R9

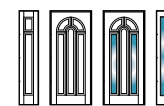



R10



R11

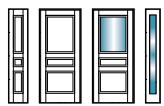

R12

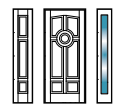

R13



R14



R15

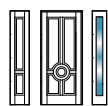

R16

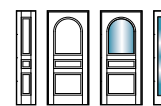

R17

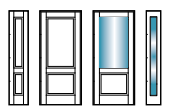



R0
Tanganika medio verticale



R0
Tanganika chiaro verticale



R0
Okume tinto ciliegio verticale



R0
Okume tinto mogano verticale



R0
Rovere caffè verticale



R0
Rovere moka verticale



R0
Laccato Bianco



R0
Laccato RAL 6005 texturizzato



R0
Rovere medio orizzontale

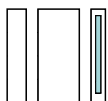

R0
Rovere caffè orizzontale

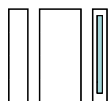

R0
Frassino tinto ciliegio orizzontale

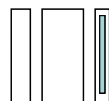

R0
Frassino moka orizzontale

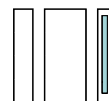

R0
Frassino spazzolato laccato bianco orizz

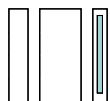

R0
Frassino spazzolato laccato grigio

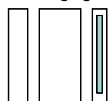

R0
Rovere spazzolato laccato avorio orizz

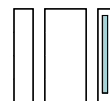

R0
Rovere spazz. lacc. tortora orizz



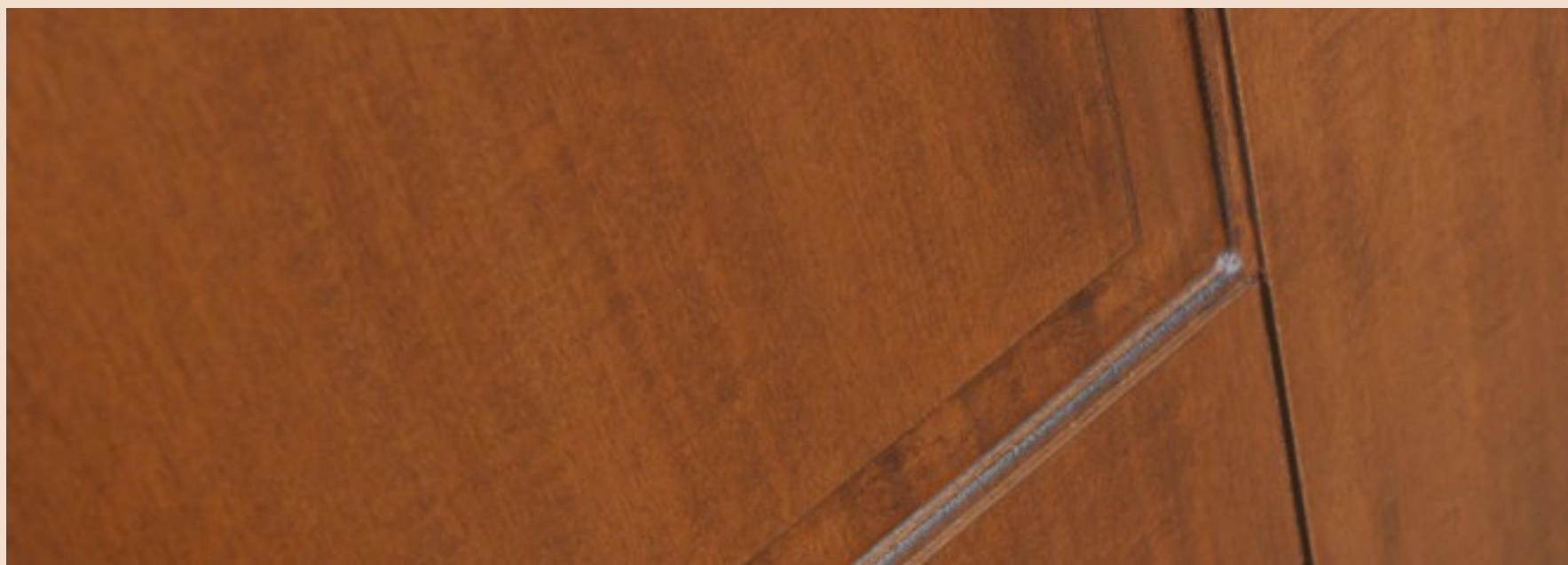

okume chiaro	okume medio	okume tinto ciliegio	okume tinto mogano	okume caffè	okume moka	
rovere chiaro	rovere medio verticale	rovere tinto ciliegio verticale	rovere cognac verticale	rovere caffè verticale	rovere moka verticale	
rovere chiaro	rovere medio orizzontale	rovere tinto ciliegio orizzontale	rovere cognac orizzontale	rovere caffè orizzontale	rovere moka orizzontale	
frassino chiaro	frassino medio	frassino tinto ciliegio	frassino cognac	frassino caffè	frassino moka	
tanganika chiaro	rovere spazz. lacc. avorio vert.	rovere spazz. lacc. avorio orizz.	frassino spazzolato laccato avorio	laccato avorio	laccato avorio texturizzato	laccato 9010
tanganika tinto ciliegio	rovere spazz. lacc. bianco vert.	rovere spazz. lacc. bianco orizz.	frassino spazzolato laccato bianco	laccato bianco	laccato bianco texturizzato	9010 texturizzato
tanganika medio	rovere spazz. lacc. grigio vert.	rovere spazz. lacc. grigio orizz.	frassino spazzolato laccato grigio	laccato grigio	laccato grigio texturizzato	laccato 6005
tanganika scuro	rovere spazz. lacc. tortora vert.	rovere spazz. lacc. tortora orizz.	frassino spazzolato laccato tortora	laccato tortora	laccato tortora texturizzato	6005 texturizzato



Versione laccata disponibile in tutte le tinte RAL.

Le tinte sono puramente indicative e non possono rappresentare oggetto di confronto con la finitura della porta.

Rivestimenti
pantografati.

A M B I E N T E



RIPARATO

U M I D I T À



C A R A N Z I A



S P E S S O R E



46

SPO



Classic



S1

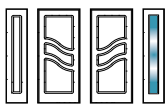

S2

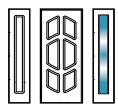

S3

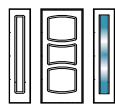

S4

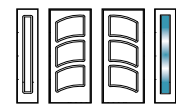

S5

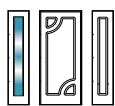

S6

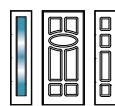

S7

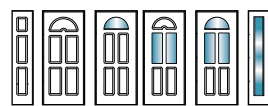

S8

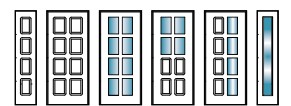



S9

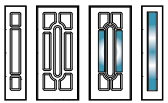

S10

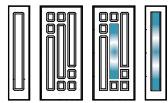

S11

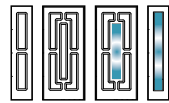

S12

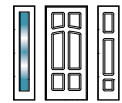

S13

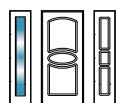

S14

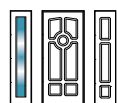

SP0

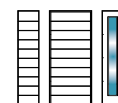

SPV

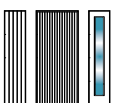



Particolare della fresata dei rivestimenti CLASSIC

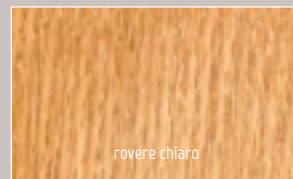

rovere chiaro

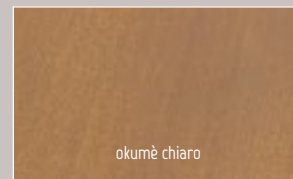

okumè chiaro

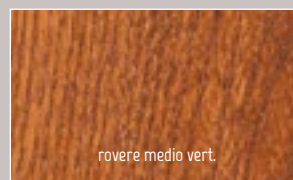

rovere medio vert.

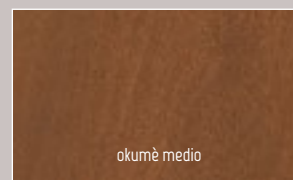

okumè medio

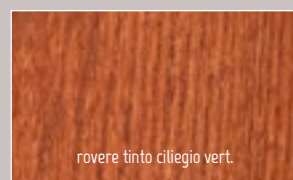

rovere tinto ciliegio vert.

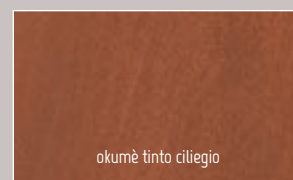

okumè tinto ciliegio

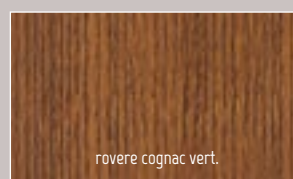

rovere cognac vert.

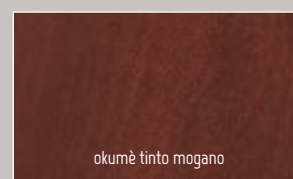

okumè tinto mogano

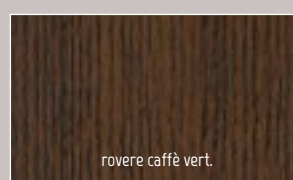

rovere caffè vert.

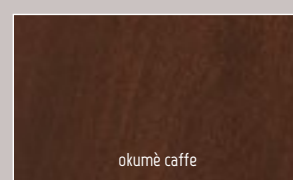

okumè caffè

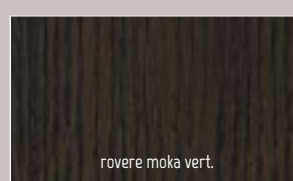

rovere moka vert.

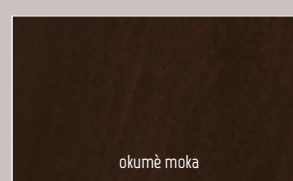

okumè moka



laccato 9010

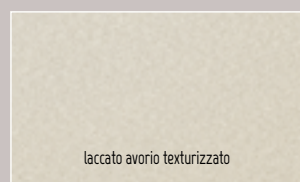

laccato avorio texturizzato

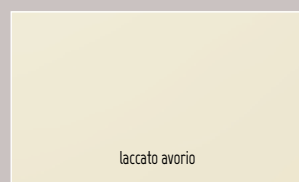

laccato avorio

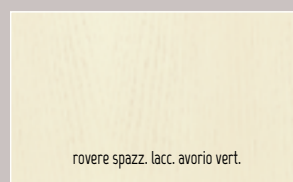

rovere spazz. lacc. avorio vert.

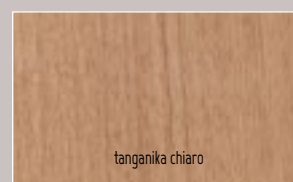

tanganika chiaro

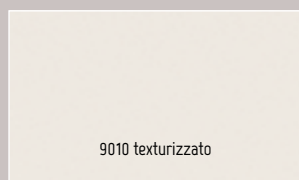

9010 texturizzato

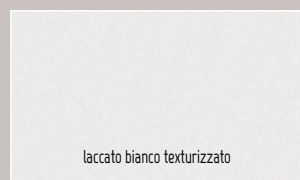

laccato bianco texturizzato



laccato bianco

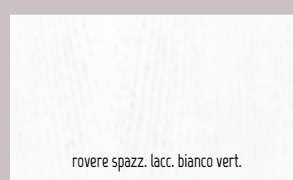

rovere spazz. lacc. bianco vert.

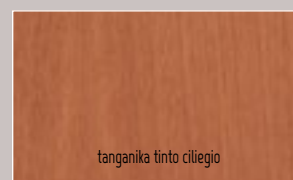

tanganika tinto ciliegio

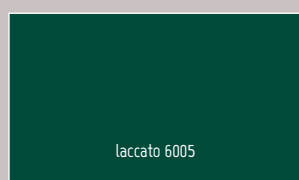

laccato 6005

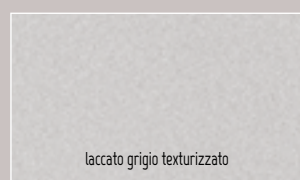

laccato grigio texturizzato

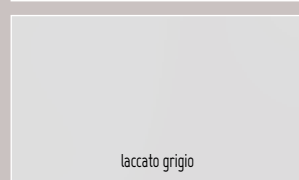

laccato grigio

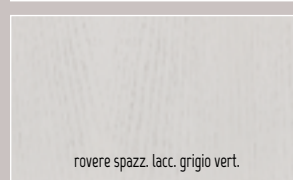

rovere spazz. lacc. grigio vert.

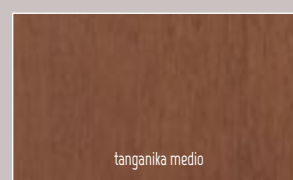

tanganika medio

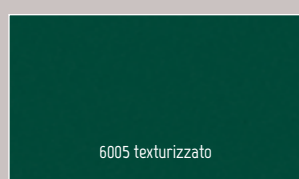

6005 texturizzato

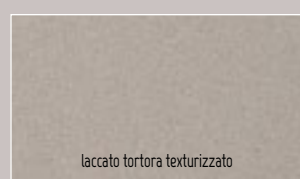

laccato tortora texturizzato

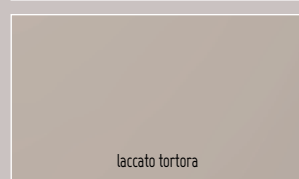

laccato tortora

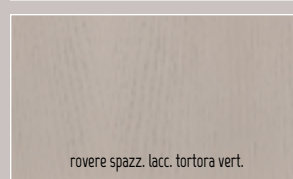

rovere spazz. lacc. tortora vert.

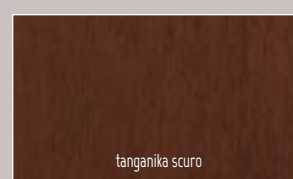

tanganika scuro



Versione laccata disponibile in tutte le tinte RAL.

Le tinte sono puramente indicative e non possono rappresentare oggetto di confronto con la finitura della porta.

Rivestimenti
pantografati
con inserti in
pietra di Luserna

AMBIENTE



UMIDITÀ



GARANZIA



SPESSORE

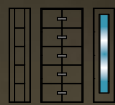

PT8

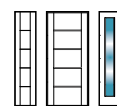

PT1

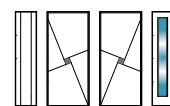

PT9



Stone

La pietra di Luserna viene estratta nelle cave del nostro territorio, il suo impiego è particolarmente indicato in ambito edilizio e decorativo.

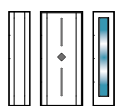

PT6

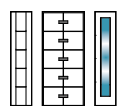

PT8

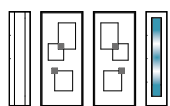
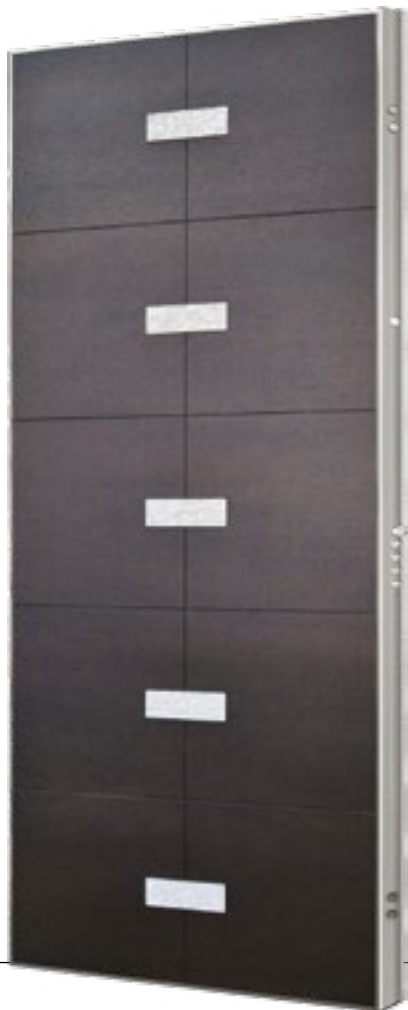

PT10



PT11

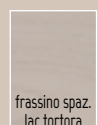
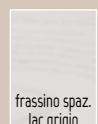
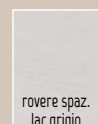
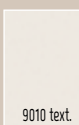
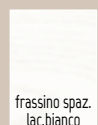
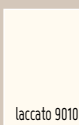
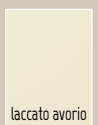
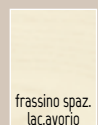
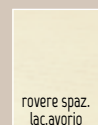
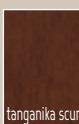
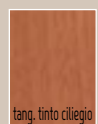
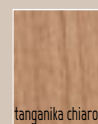
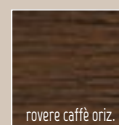
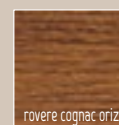
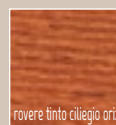
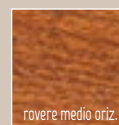
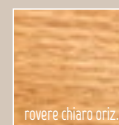
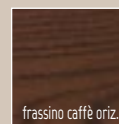
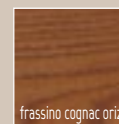
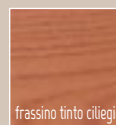
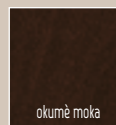
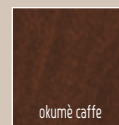
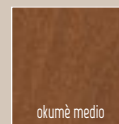
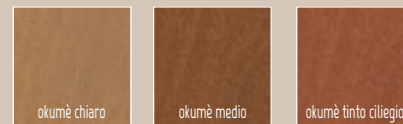

Versione laccata disponibile in tutte le tinte RAL.

Finiture disponibili

Le tinte sono puramente indicative e non possono rappresentare oggetto di confronto con la finitura della porta.

Rivestimenti
pantografati
con chiodatura
antichizzata

A M B I E N T E



U M I D I T À



G A R A N Z I A



S P E S S O R E

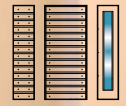

T5

Rustici



T1



T2



T4



T5

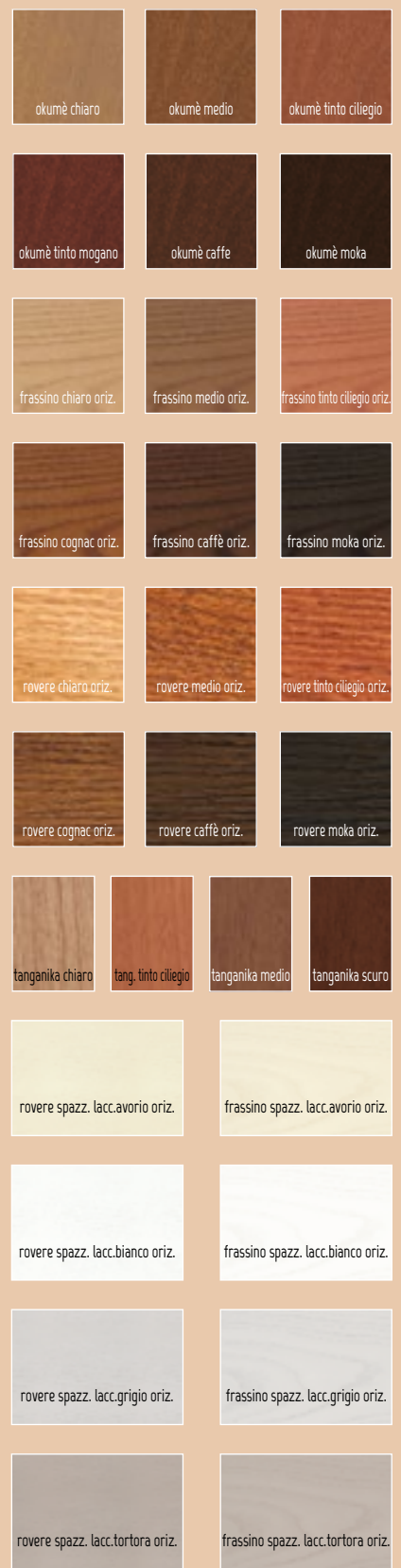

Versione laccata disponibile in tutte le tinte RAL.

Finiture disponibili

Le tinte sono puramente indicative e non possono rappresentare oggetto di confronto con la finitura della porta.

Rivestimenti
in HPL "high
pressure laminate"

AMBIENTE



RIPARATO

UMIDITÀ



GARANZIA



2 ANNI

SPESSORE



6



14

HPL-A
nero

Surface

HPL-A effetto pietra



HPL-A
bianco



HPL-A
pomice

Non disponibili in versione finestrata e per porte doppie



HPL-A
grigio



HPL-A
tortora

Le tinte sono puramente indicative e non possono rappresentare oggetto di confronto con la finitura della porta.



HPL-C
bianco

Surface HPL-C simil pelle

HPL-S
bianco



HPL-S
nero



HPL-S
grigio

Non disponibili in versione finestrata e per porte doppie



HPL-S
tortora



HPL-S
pomice

Le tinte sono puramente indicative e non possono rappresentare oggetto di confronto con la finitura della porta.

Surface HPL-S effetto scolpito



HPL-L
bianco



HPL-L
pomice

Non disponibili in versione finestrata e per porte doppie



HPL-L
grigio



HPL-L
tortora

Le tinte sono puramente indicative e non possono rappresentare
oggetto di confronto con la finitura della porta.



HPL-L
nero

Surface HPL-L effetto lucido



Antigraffio



Facile da pulire



Resistente ai solventi



Anti-impronta



Morbido al tatto



Idrorepellente

Un materiale
super opaco
che grazie alle
sua superficie
particolare offre
prestazioni
tecnologiche
all'avanguardia



HPL-Z
grigio Londra



Surface HPL-Z effetto opaco



HPL-Z
bianco

HPL-Z
nero

Non disponibili in versione finestrata e per porte doppie



HPL-Z
grigio chiaro

HPL-Z
tortora

Le tinte sono puramente indicative e non possono rappresentare oggetto di confronto con la finitura della porta.



HPL-C simil pelle



HPL-A effetto pietra nero

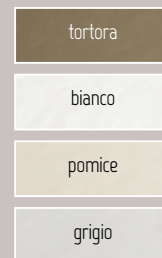

HPL-S effetto scolpito tortora

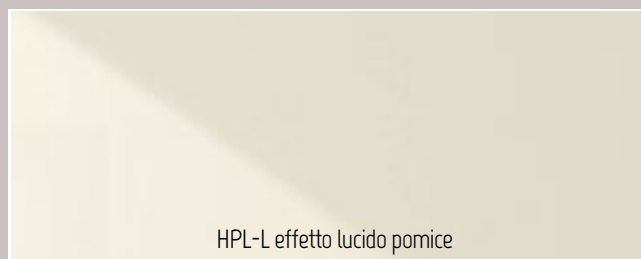
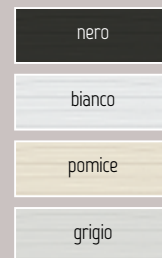

HPL-L effetto lucido pomice

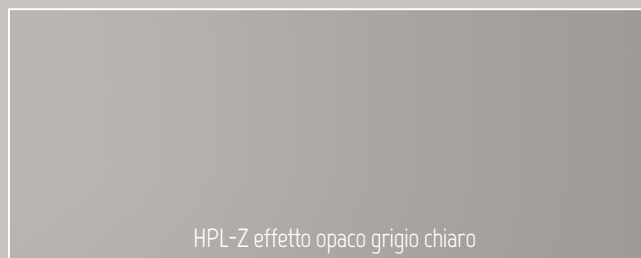
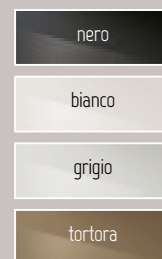

HPL-Z effetto opaco grigio chiaro

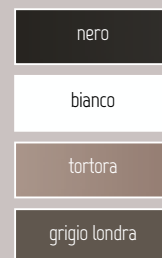

Pannelli rivestimenti disponibili in finiture pastello HPL-P

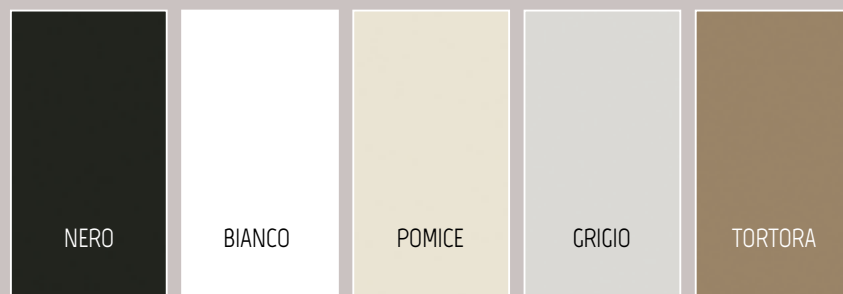

Altre finiture a richiesta

Rivestimenti
pantografati
incisi su mdf
con laccatura
opaca.

A M B I E N T E



U M I D I T À



C A R A N Z I A



S P E S S O R E



F126
laccato bianco

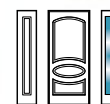

Chrome



F106
laccato bianco



F107
laccato avorio



F108
laccato avorio



F109
laccato grigio



F112
laccato RAL



F113
laccato tortora



F114
laccato tortora



F117
laccato RAL 6005



F118
laccato grigio



F121
laccato avorio



F154
laccato bianco

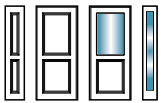

F155
laccato grigio

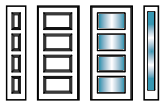

F156
laccato RAL



F157
laccato RAL

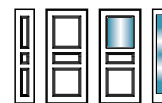

F134
laccato grigio



F135
laccato bianco



F138
laccato avorio

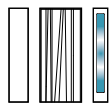

F139
laccato tortora

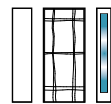

F141
laccato avorio

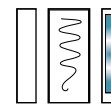

F145
laccato bianco

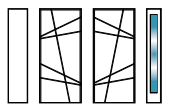



F146
laccato tortora



F147
laccato bianco



F148
laccato bianco



F149
laccato bianco



F150
laccato avorio



F151
laccato tortora



F152
laccato bianco



F153
laccato grigio



FS4
laccato tortora con filetti in alluminio



FS5
laccato tortora con filetti in alluminio



FS6
laccato tortora con filetti in alluminio



FS7
laccato tortora con filetti in alluminio



FFA
laccato tortora



FFC
laccato grigio



FFD
laccato bianco



FFF
laccato grigio



FFH
laccato bianco



FF2
laccato tortora



FF4
laccato tortora



FF7
laccato avorio



F129
laccato RAL 1015



Particolare fresata classica

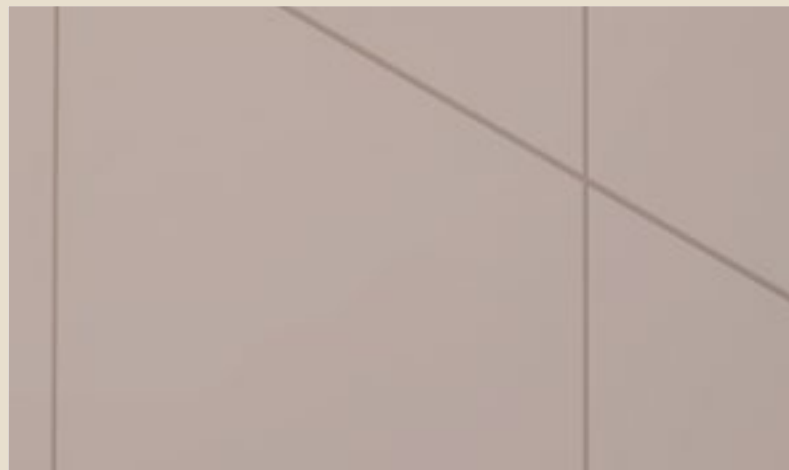

Particolare incisione



Particolare fresata lineare



Particolare fresata a sfumare

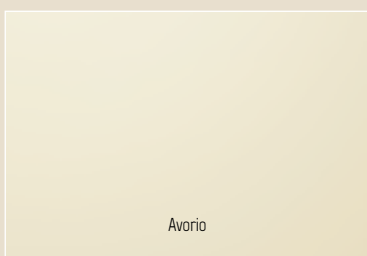

Avorio

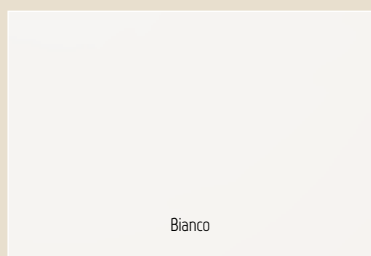

Bianco

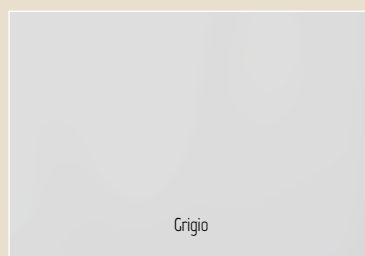

Grigio

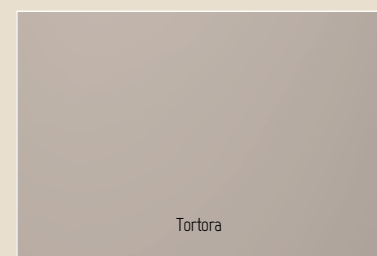

Tortora

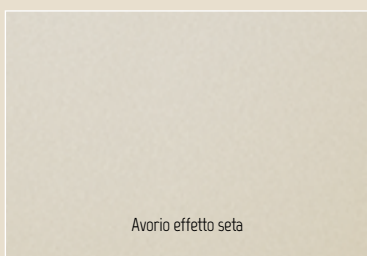

Avorio effetto seta

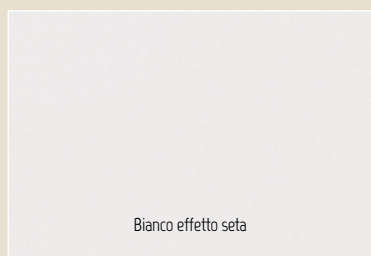

Bianco effetto seta

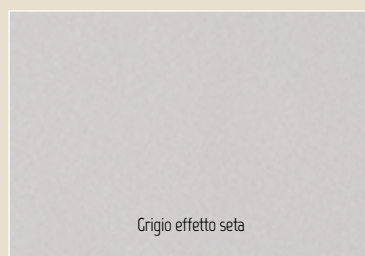

Grigio effetto seta



Tortora effetto seta

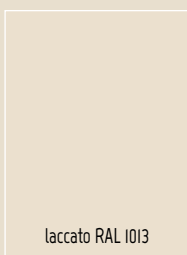

laccato RAL 1013



laccato RAL 1015

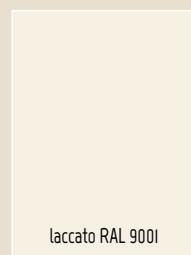

laccato RAL 9001

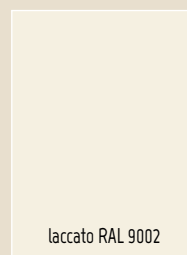

laccato RAL 9002



laccato RAL 9003



laccato RAL 9010



laccato RAL 9016



Versione laccata disponibile in tutte le tinte RAL.

Le tinte sono puramente indicative e non possono rappresentare oggetto di confronto con la finitura della porta.

Rivestimenti in
mdf impiallacciati
in essenza

A M B I E N T E



U M I D I T À



G A R A N Z I A



S P E S S O R E



D10

Concept

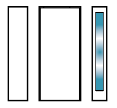

D1

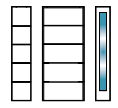

D2



D5

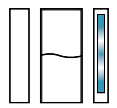

D6

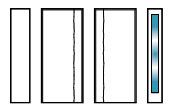

D8

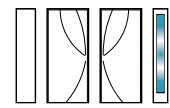

D10



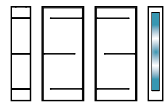

D15

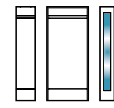

D16

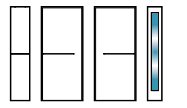

D17

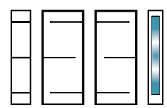

D15

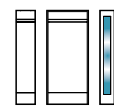

D16

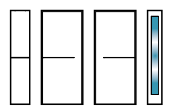

D17

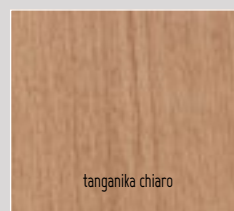

tanganika chiaro



rovere spazz. lacc. avorio orizz.

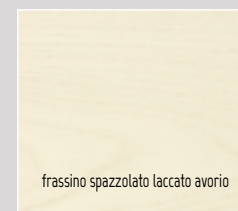

frassino spazzolato laccato avorio



tanganika tinto ciliegio

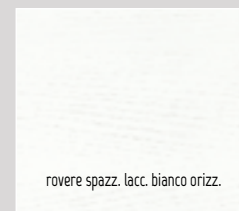

rovere spazz. lacc. bianco orizz.

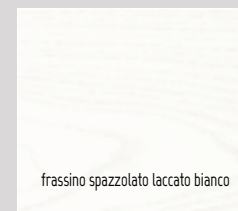

frassino spazzolato laccato bianco



tanganika medio

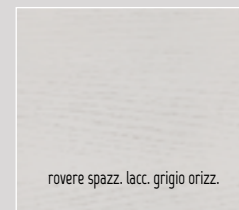

rovere spazz. lacc. grigio orizz.

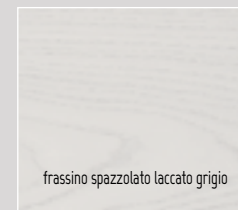

frassino spazzolato laccato grigio



tanganika perlato

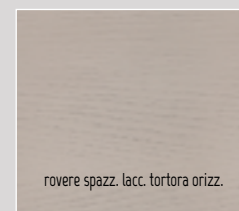

rovere spazz. lacc. tortora orizz.

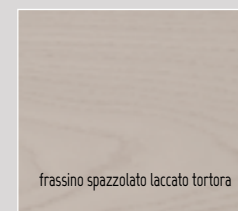

frassino spazzolato laccato tortora

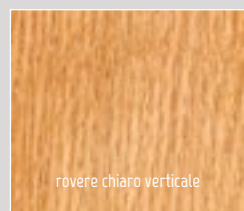

rovere chiaro verticale

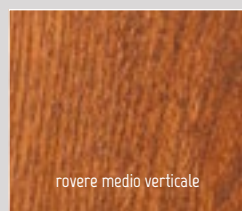

rovere medio verticale



rovere tinto ciliegio verticale

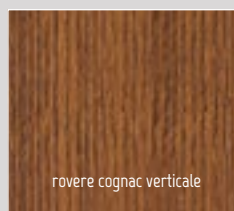

rovere cognac verticale

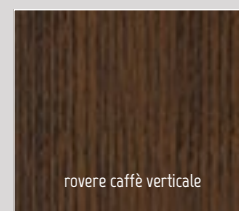

rovere caffè verticale

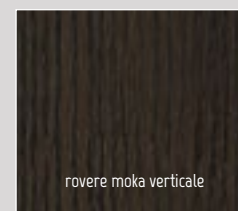

rovere moka verticale



rovere chiaro orizzontale

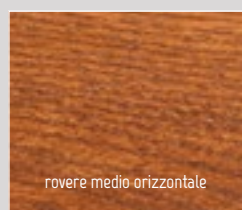

rovere medio orizzontale

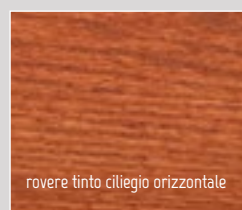

rovere tinto ciliegio orizzontale

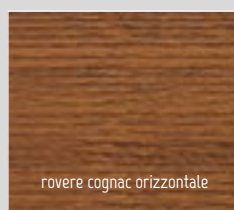

rovere cognac orizzontale

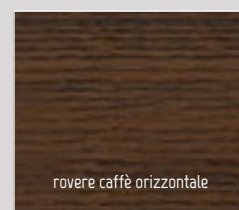

rovere caffè orizzontale

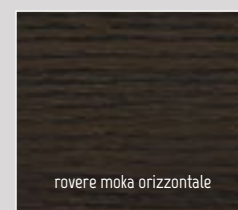

rovere moka orizzontale



frassino chiaro verticale

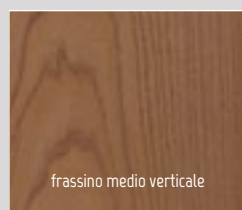

frassino medio verticale



frassino tinto ciliegio verticale

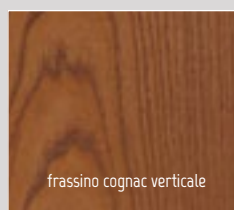

frassino cognac verticale

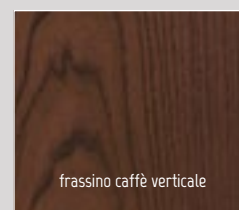

frassino caffè verticale

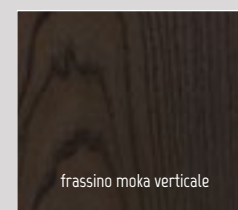

frassino moka verticale

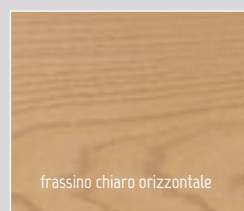

frassino chiaro orizzontale



frassino medio orizzontale

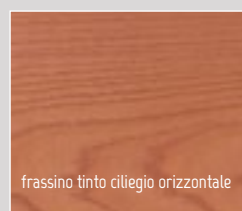

frassino tinto ciliegio orizzontale



frassino cognac orizzontale

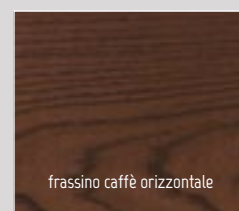

frassino caffè orizzontale



frassino moka orizzontale

Rivestimenti in
mdf impiallacciati
in essenza

A M B I E N T E



U M I D I T À



G A R A N Z I A



S P E S S O R E

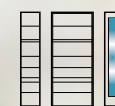

RS04-R

Reset

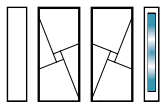

RS01-i

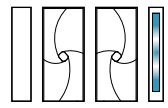

RS02-i

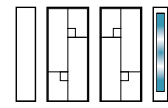

RS03-i

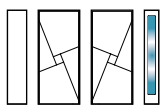

RS01-R

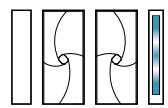

RS02-R

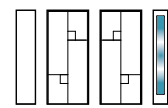

RS03-R



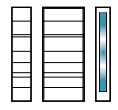

RS04-i

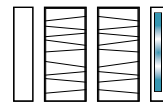

RS05-i

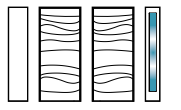

RS06-i

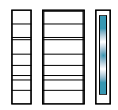

RS04-R

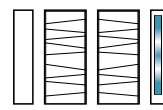

RS05-R

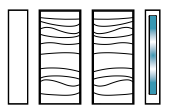

RS06-R



Particolare modello R (ribassato)



Particolare modello i (inciso)

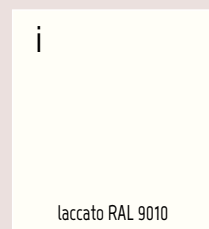
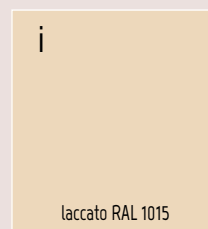
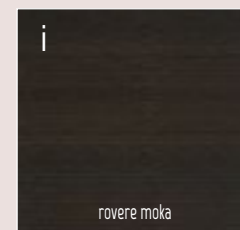
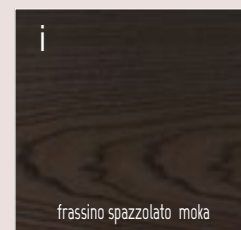
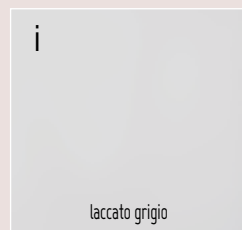
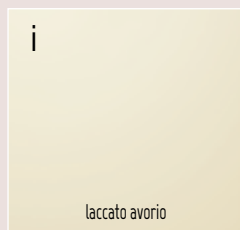
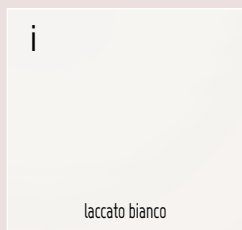
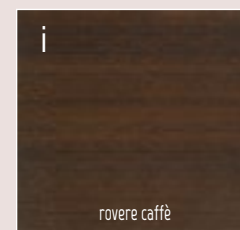
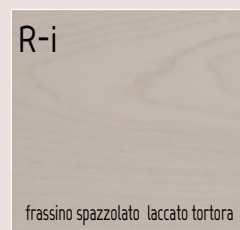
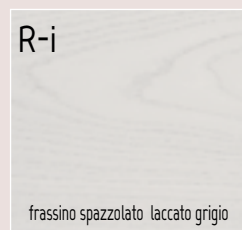
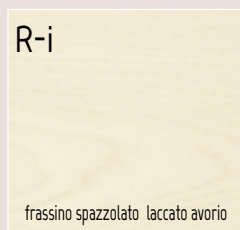
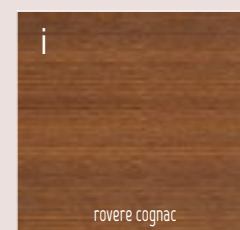
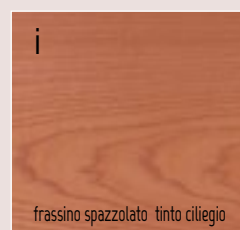
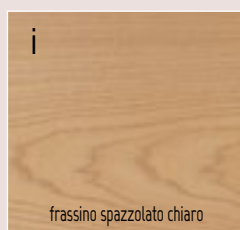

Versione laccata disponibile in tutte le tinte RAL.

Le tinte sono puramente indicative e non possono rappresentare oggetto di confronto con la finitura della porta.

Rivestimenti
in mdf rivestiti
con pellicole
in laminato
con laccatura
opaca

AMBIENTE



UMIDITÀ



GARANZIA



SPESSORE

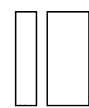

LV00

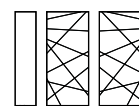

LV03



Living

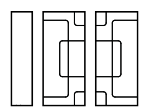

LV01

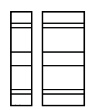

LV02

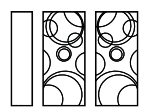

LV04

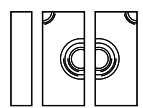

LV05

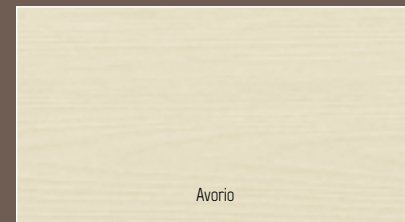

Avorio

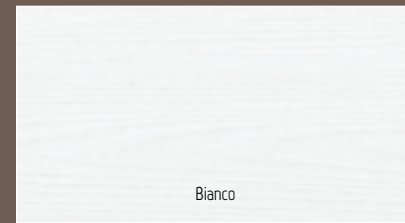

Bianco

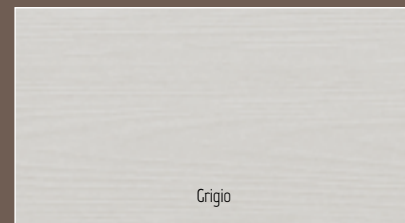

Grigio

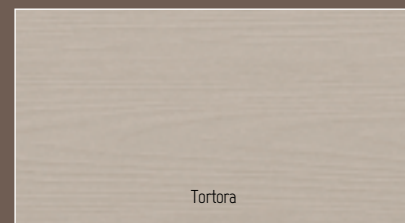

Tortora



RAL 9001

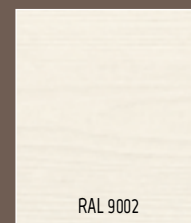

RAL 9002



RAL 1013



RAL 1015



RAL 9003



RAL 9010



RAL 9016

Finiture disponibili



Versione laccata disponibile in tutte le tinte RAL.

Le tinte sono puramente indicative e non possono rappresentare oggetto di confronto con la finitura della porta.

Rivestimenti in
mdf/truciolare
impiallacciati
in essenza

AMBIENTE



UMIDITÀ



GARANZIA



SPESSORE



LS
rovere bianco perlato

Easy



LS
rovere tinto ciliegio

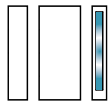

LS
tanganika medio

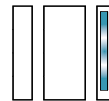

LS
mogano medio

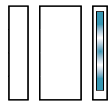

LS
noce nazionale

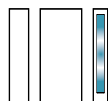

LS
laccato bianco



LS
laccato tortora

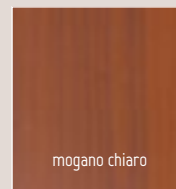
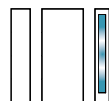

mogano chiaro

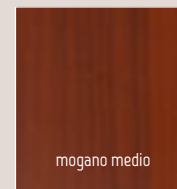

mogano medio

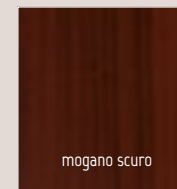

mogano scuro

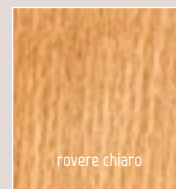

rovere chiaro

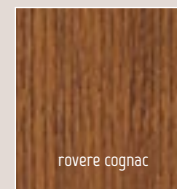

rovere cognac

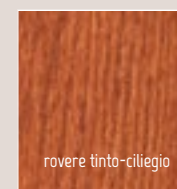

rovere tinto-ciliegio



rovere bianco perlato

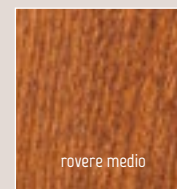

rovere medio

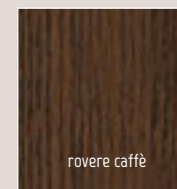

rovere caffè

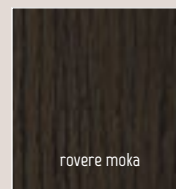

rovere moka

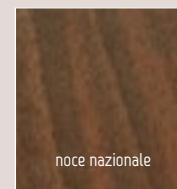

noce nazionale



tanganika chiaro

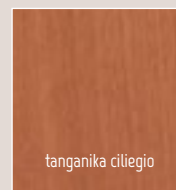

tanganika ciliegio

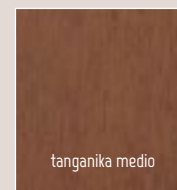

tanganika medio

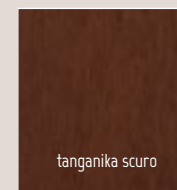

tanganika scuro

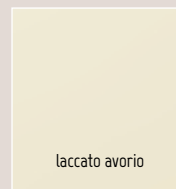

laccato avorio



laccato grigio



laccato bianco

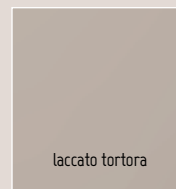

laccato tortora



laccato RAL 9010

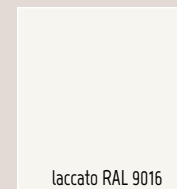

laccato RAL 9016



laccato RAL 1013



laccato RAL 1015



laccato RAL 9003



laccato RAL 9001



laccato RAL 9002

Le tinte sono puramente indicative e non possono rappresentare oggetto di confronto con la finitura della porta.

LM
vena orizzontale



Rivestimenti
in MDF rivestiti
con pellicole in
laminato.

A M B I E N T E



U M I D I T À



C A R A N Z I A



S P E S S O R E



Laminate

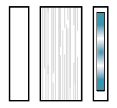

LM
vena verticale

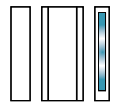

LM5

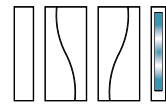

LM6

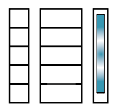

LM7

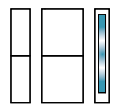

LM8

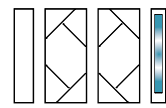

LM13





LM14

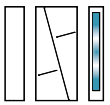

LM15

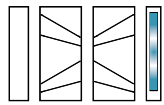

LM16

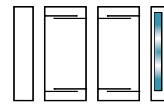

LM18

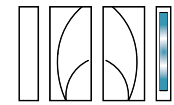

LM19

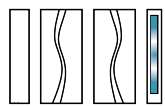

LM20

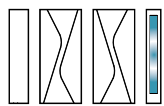

LM21

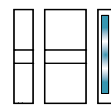

LM22

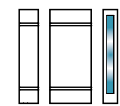

FINITURE CON VENA ORIZZONTALE



Bianco nuvola



Bianco spazzolato



Grigio cenere

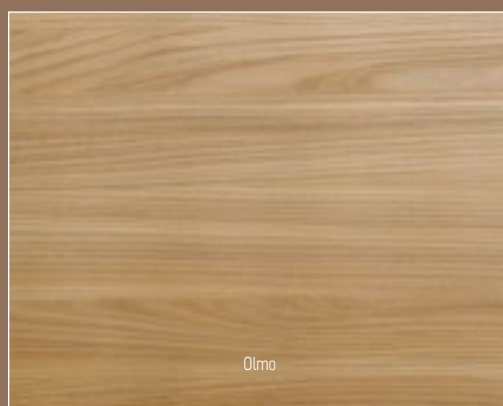

Olmo

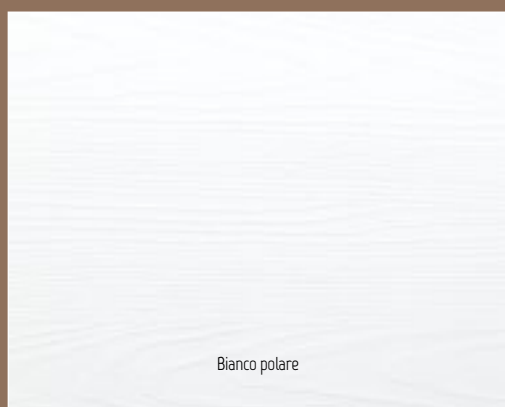

Bianco polare



Quercia perla

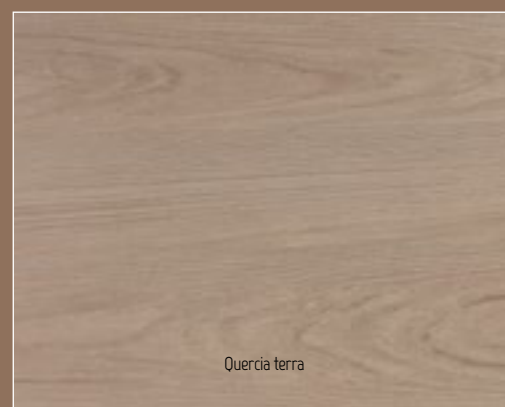

Quercia terra

FINITURE CON VENA VERTICALE

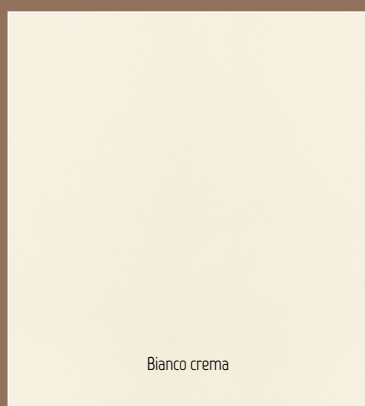

Bianco crema

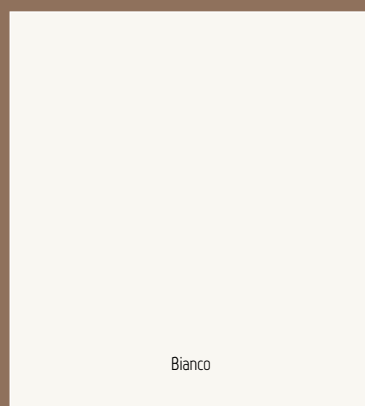

Bianco

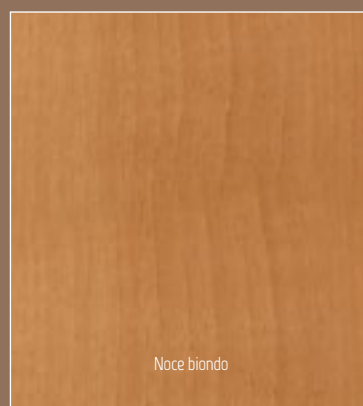

Noce biondo



Noce zen

Finiture disponibili

EA4

Rivestimenti con
applicazione di
profili in legno
(Cornici, zoccoli,
piattabande)

A M B I E N T E



U M I D I T À



G A R A N Z I A



S P E S S O R E



Pannelli costruiti su due
livelli con cornici riportate
ai bordi delle riquadrature

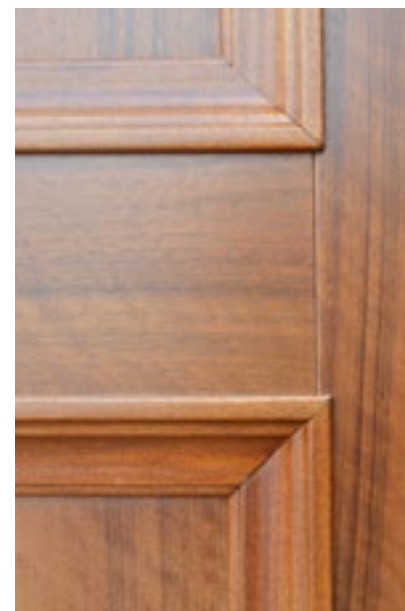

Esempi di soluzioni disponibili

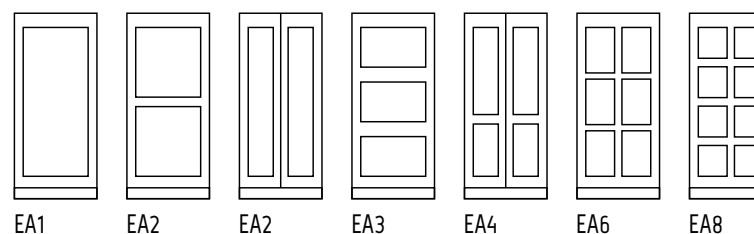

EA1

EA2

EA2

EA3

EA4

EA6

EA8

Assembly

Essenze disponibili
Tanganika, Mogano, Rovere, Laccato, Noce Nazionale



Pannelli costruiti su due livelli con cornici riportate ai bordi delle riquadrature con aggiunta di piattabanda centrale

Esempi di soluzioni disponibili

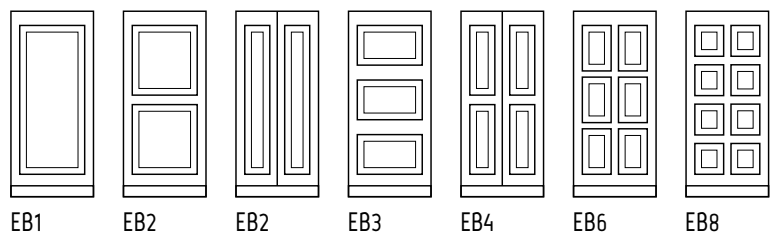

EB1 EB2 EB2 EB3 EB4 EB6 EB8

Essenze disponibili
Tanganika, Mogano, Rovere, Laccato, Noce Nazionale



EB3

Rivestimenti con
applicazione di
profili in legno
(Cornici, zoccoli
piattabande)

AMBIENTE



UMIDITÀ



GARANZIA



SPESSORE

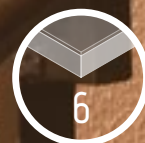

Esempio di applicazione fino a tre profili lineari

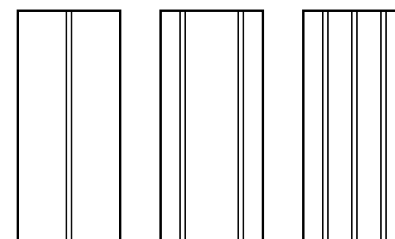

Esempio di applicazione fino a tre riquadri

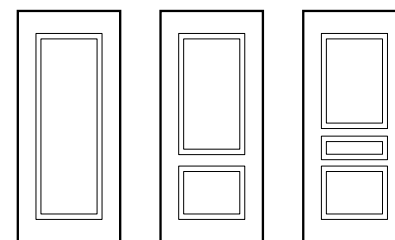

Esempio di applicazione fino a 10 riquadri

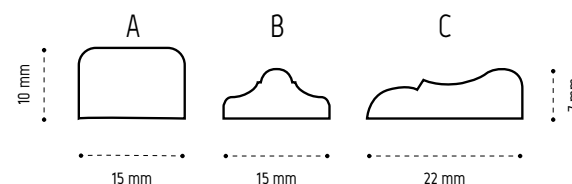
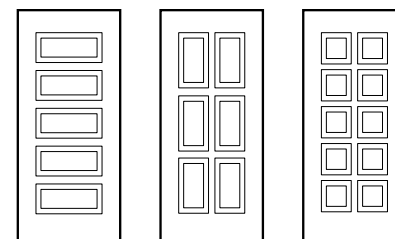

Finiture disponibili:
Tanganika
Mogano
Rovere
Noce Nazionale
Laccato

Rilievi

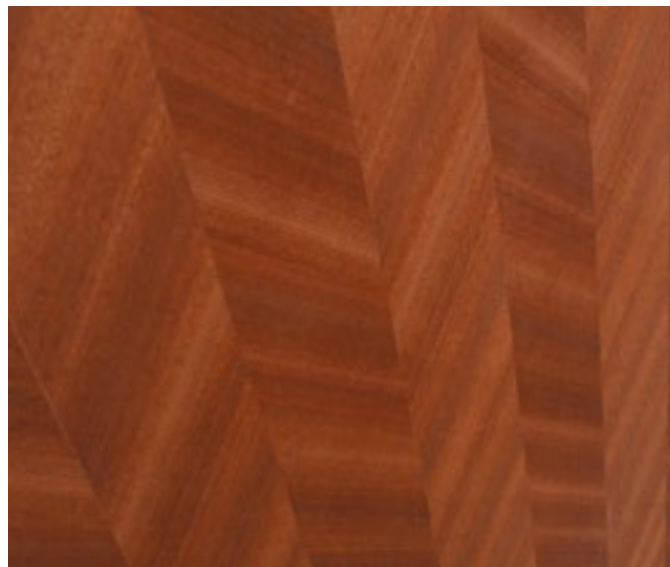

Rivestimenti in
mdf/truciolare
intarsiati in
essenza

Alcuni esempi

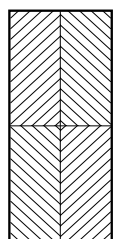

CS-A1

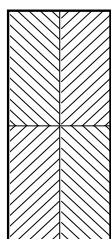

CS-A2

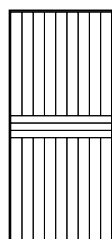

CS-A3

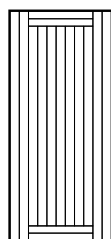

CS-A4

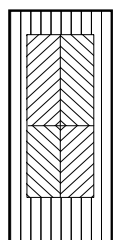

CS-B1

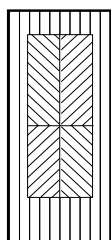

CS-B2

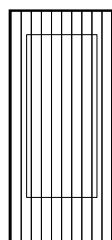

CS-B3

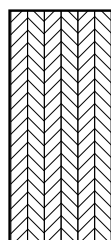

CS-B4

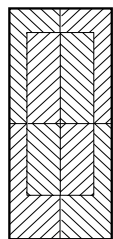

CS-C1

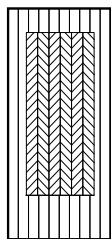

CS-C2

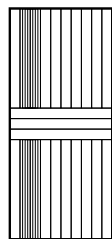

CS-C3

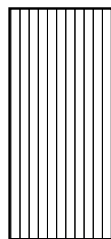

CS-C4

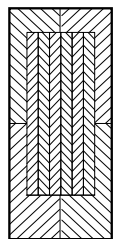

CS-D1

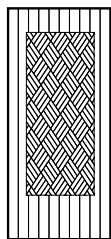

CS-D2

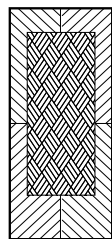

CS-D3

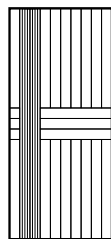

CS-D4

Finiture disponibili:
Mogano, Tanganika, Rovere,
Noce Nazionale, Ciliegio, Castagno,
Frassino, Douglas
Modelli con filetti in acero
disponibili solo con verniciatura naturale

AMBIENTE



UMIDITÀ



GARANZIA



SPESSORE



Intarsi

Pensiline



Si installano facilmente: sono fornite in Kit complete di tutta la viteria e le istruzioni per il montaggio. Grazie ad un sistema di assemblaggio rapido e brevettato la pensilina si installa in modo facile e veloce.

Modulari: il sistema modulare permette di unire più moduli, l'uno dopo l'altro, si può raggiungere qualsiasi larghezza. Grazie a questo sistema, ordinando altri moduli, si può prolungare la pensilina in qualsiasi momento.

Complete: la grondaia ben integrata nel design della pensilina, raccoglie e convoglia l'acqua sugli appositi scarichi laterali, eliminando definitivamente i fastidiosi gocciolamenti davanti alla porta d'ingresso.

Curate in ogni dettaglio: L'assemblaggio e l'installazione non lascia viti a vista ed una speciale guarnizione in gomma, evita le infiltrazioni di acqua fra muro e pensilina.

Certificate: Sono pronte a tutto! Per loro pioggia, neve, grandine e vento non rappresentano una minaccia. Sopportano carichi fino a 200 kg/mq. nelle condizioni di prova, come certificate L'ISTEDIL.

Durano una vita: progettate e costruite interamente in Italia con materiali di prima qualità, sono garantite 10 anni contro la corrosione delle parti in alluminio, l'ingiallimento della copertura e la reperibilità dei ricambi.

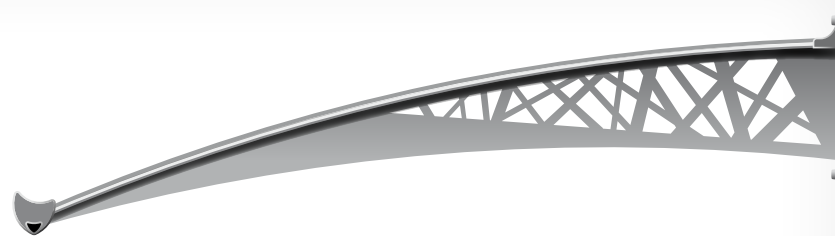

Pensilina T



Pensilina A



Pensilina B



Pensilina C

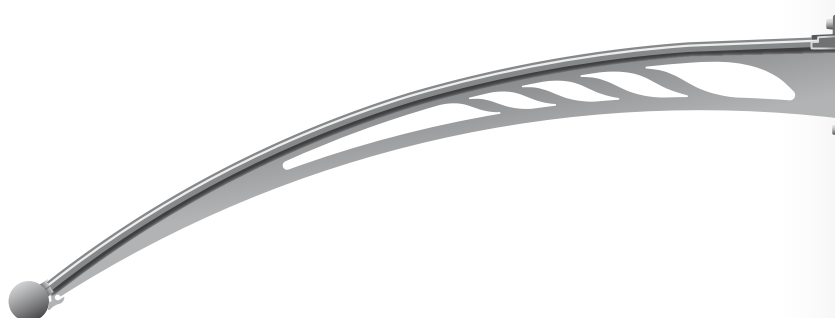

Pensilina BASIC

Pensilina **BASIC**

PENSILINA BASIC è un sistema modulare che ti permette di realizzare rapidamente la soluzione più adatta alle tue esigenze. Combinando gli elementi della PENSILINA BASE e dei MODULI AGGIUNTIVI, disponibili in varie larghezze, potrai costruire con estrema facilità la tua pensilina nella misura desiderata. Con i FLAP laterali opzionali, puoi inoltre prolungare e rifinire la copertura della pensilina, un sistema funzionale per rendere unico il tuo ingresso.

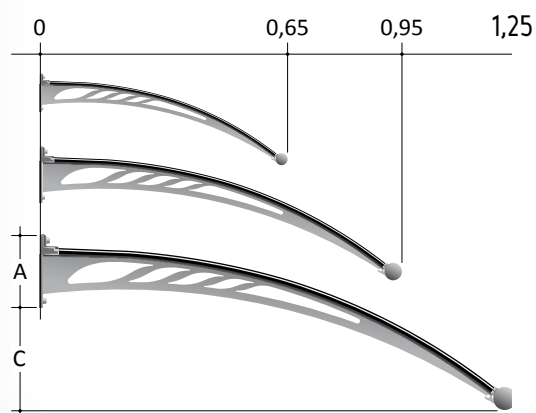

Mensole portanti in acciaio trattate contro la corrosione, verniciate con polveri epossidiche colore antracite di serie (altri colori a richiesta). Grondaia e sovrastruttura in alluminio estruso 6060/T5, colore argento satinato (unica finitura disponibile). Copertura in policarbonato semitrasparente con protezione UV, in finitura Frosted (unica finitura disponibile). Viteria per l'installazione fornita di serie.

Pensilina T



Pensilina a sbalzo con carico di 200 kg/mq (nelle condizioni di prova come certificate da ISTEUIL), disponibile nelle misure standard e su misura, composta da:

- Mensole portanti in acciaio sagomato dotate, nel loro intradosso, di apposito sistema premi-lastra in lega di alluminio 6060/T5 brevettato, con funzione di bloccaggio della copertura, senza interposizione di guarnizioni o fissaggi puntiformi per consentirne il libero movimento generato dalle escursioni termiche.
- Profilo di rifinitura a muro in lega di alluminio 6060/T5, atto a contenere la lastra di copertura, dotato di guarnizione per evitare le infiltrazioni di acqua fra muro e pensilina.
- Grondaia in lega di alluminio estruso 6060/T5, atta a contenere la lastra di copertura, dotata di terminali di scolo.
- Copertura in vetro acrilico anti-urto resistente ai raggi U.V. di spessore 4 mm, alloggiata all'interno delle scanalature ricavate nel profilo di rifinitura e nella grondaia.

Prodotto fornito in Kit corredato di viteria in acciaio inox AISI 304 non a vista. Tutte le parti in metallo sono trattate con processi anti-corrosione verniciate a polveri di poliestere nei colori di serie o su richiesta.

Pensilina A

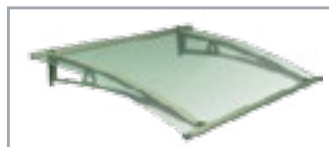
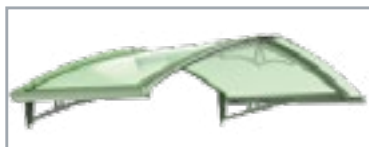
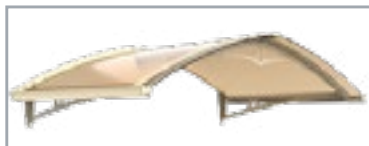
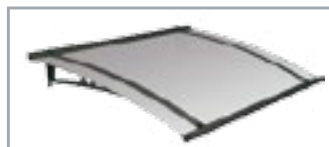

Pensilina a sbalzo con carico di 200 kg/mq (nelle condizioni di prova come certificate da ISTDIL), disponibile nelle misure standard e su misura, composta da:

- Mensole portanti in acciaio sagomato dotate, nel loro intradosso, di apposito sistema premi-lastra in lega di alluminio 6060/T5 brevettato, con funzione di bloccaggio della copertura, senza interposizione di guarnizioni o fissaggi puntiformi per consentirne il libero movimento generato dalle escursioni termiche.
- Profilo di rifinitura a muro in lega di alluminio 6060/T5, atto a contenere la lastra di copertura, dotato di guarnizione per evitare le infiltrazioni di acqua fra muro e pensilina.
- Grondaia in lega di alluminio estruso 6060/T5, atta a contenere la lastra di copertura, dotata di terminali di scolo.
- Copertura in vetro acrilico anti-urto resistente ai raggi U.V. di spessore 4 mm, alloggiata all'interno delle scanalature ricavate nel profilo di rifinitura e nella grondaia.

Prodotto fornito in Kit corredato di viteria in acciaio inox AISI 304 non a vista. Tutte le parti in metallo sono trattate con processi anti-corrosione verniciate a polveri di poliestere nei colori di serie o su richiesta.

Pensilina B

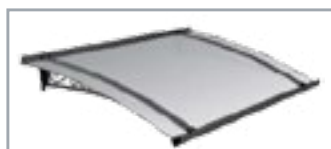
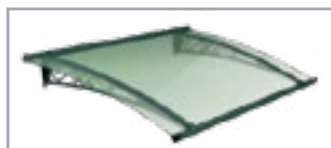
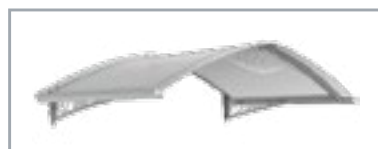

Pensilina a sbalzo con carico di 200 kg/mq (nelle condizioni di prova come certificate da ISTE DIL), disponibile nelle misure standard e su misura, composta da:

- Mensole portanti in acciaio sagomato dotate, nel loro intradosso, di apposito sistema premi-lastra in lega di alluminio 6060/T5 brevettato, con funzione di bloccaggio della copertura, senza interposizione di guarnizioni o fissaggi puntiformi per consentirne il libero movimento generato dalle escursioni termiche.
- Profilo di rifinitura a muro in lega di alluminio 6060/T5, atto a contenere la lastra di copertura, dotato di guarnizione per evitare le infiltrazioni di acqua fra muro e pensilina.
- Grondaia in lega di alluminio estruso 6060/T5, atto a contenere la lastra di copertura, dotata di terminali di scolo.
- Copertura in vetro acrilico anti-urto resistente ai raggi U.V. di spessore 4 mm, alloggiata all'interno delle scanalature ricavate nel profilo di rifinitura e nella grondaia.

Prodotto fornito in Kit corredato di viteria in acciaio inox AISI 304 non a vista. Tutte le parti in metallo sono trattate con processi anti-corrosione verniciate a polveri di poliestere nei colori di serie o su richiesta.

Pensilina C

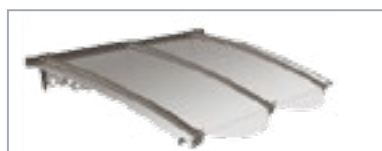

Pensilina a sbalzo con carico di 200 kg/mq (nelle condizioni di prova come certificate da ISTDIL), disponibile nelle misure standard e su misura, composta da:

- Mensole portanti in acciaio sagomato dotate, nel loro intradosso, di apposito sistema premi-lastra in lega di alluminio 6060/T5 brevettato, con funzione di bloccaggio della copertura, senza interposizione di guarnizioni o fissaggi puntiformi per consentirne il libero movimento generato dalle escursioni termiche.
- Profilo di rifinitura a muro in lega di alluminio 6060/T5, atto a contenere la lastra di copertura, dotato di guarnizione per evitare le infiltrazioni di acqua fra muro e pensilina.
- Tiranti in lega di alluminio estruso 6060/T5, atti a distanziare le mensole e sorreggere le lastre di copertura dal lato estremo della sporgenza.
- Copertura in vetro acrilico anti-urto resistente ai raggi U.V. di spessore 4 mm, con forma arrotondata dalla parte spiovente, alloggiata all'interno delle scanalature ricavate nel profilo di rifinitura.

Prodotto fornito in Kit corredato di viteria in acciaio inox AISI 304 non a vista. Tutte le parti in metallo sono trattate con processi anti-corrosione verniciate a polveri di poliestere nei colori di serie o su richiesta.

Colori disponibili della struttura

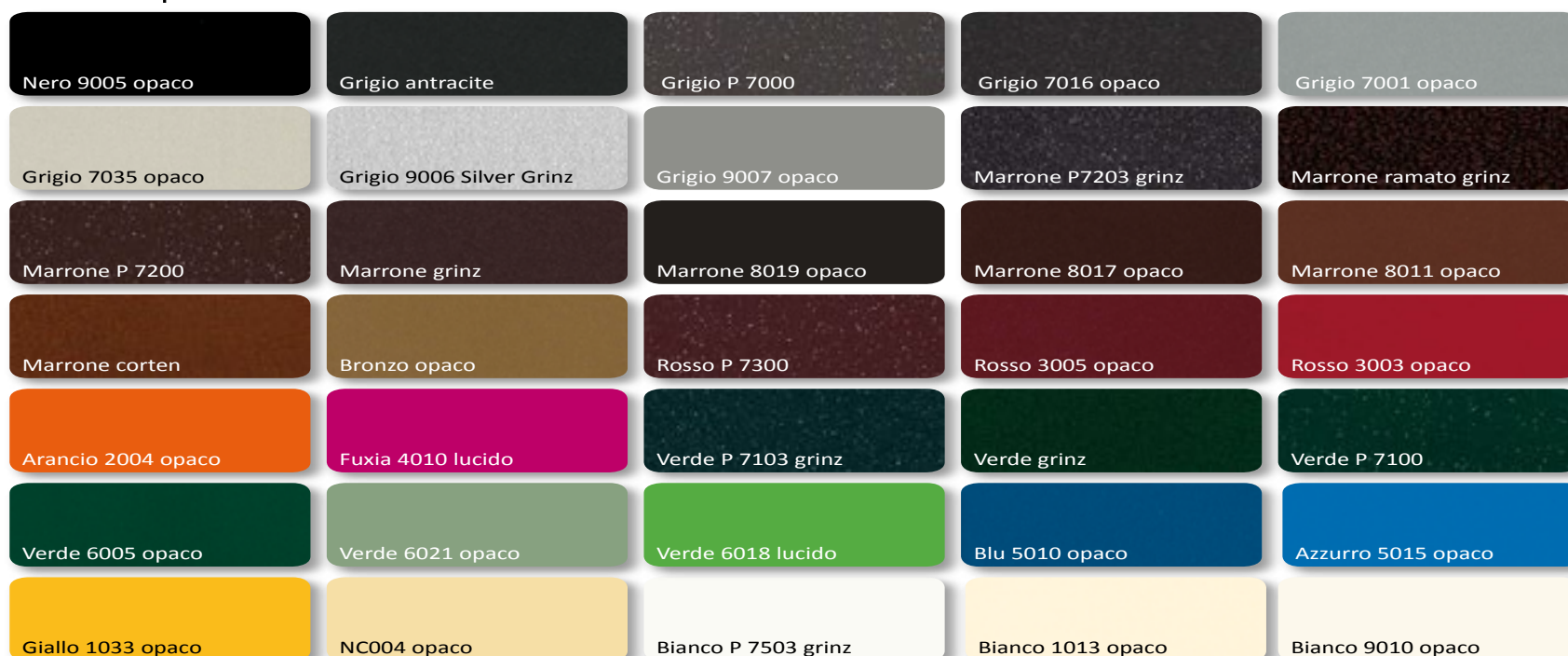

Colori disponibili della copertura pensilina

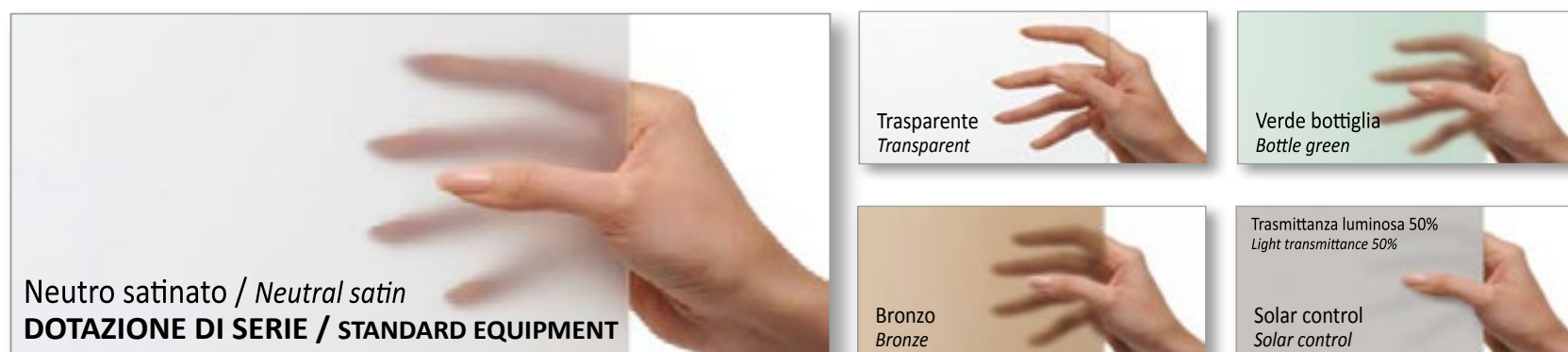

Non si rompe e non ingiallisce. La copertura delle pensiline Newentry è costituita da lastre in vetro acrilico antiurto Poly-Plex spessore 4mm. Per l'elevata resistenza ai raggi ultravioletti e l'ottimo grado di resistenza agli urti, le lastre in Poly-Plex rappresentano la migliore soluzione disponibile sul mercato per questo tipo di applicazioni.

Carichi massimi delle varie pensiline

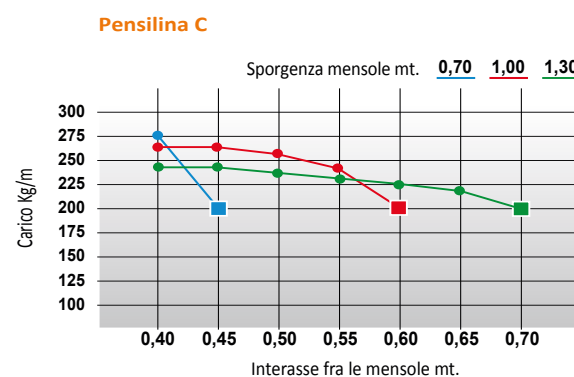
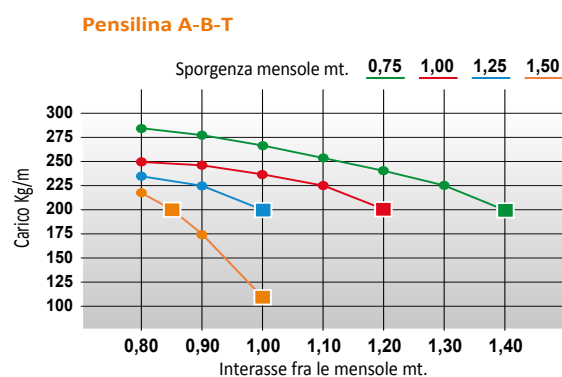
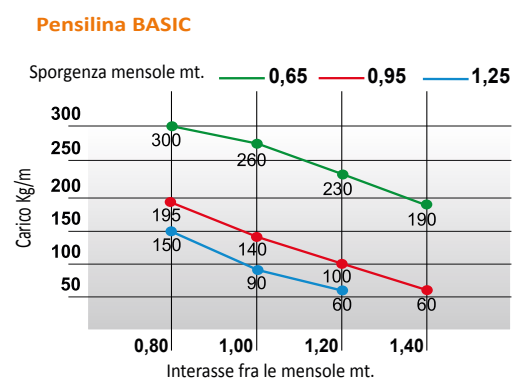

STARK s.r.l.
Via Ghiare 1/A - 12032 San Martino Barge (Cn) - Italia
Tel. +39 0175 349015 - Fax +39 0175 349749 - info@starksicurezza.com

www.starksicurezza.com

Certificazioni

STARK s.r.l. progetta e realizza tutti i suoi prodotti in osservanza al sistema di gestione della qualità secondo le normative prescritte dalla UNI EN ISO 9001:2008.

STARK s.r.l. designs and manufactures all of its products in accordance with the system of quality management according to the standards prescribed by the UNI EN ISO 9001:2008.

Le finiture ed i colori illustrati nel presente catalogo sono da considerarsi puramente indicativi; Stark s.r.l. si riserva, anche senza preavviso, di apportare ai prodotti lievi modifiche e/o migliorie tecniche ed estetiche.

The finishes and colors shown in this catalog are purely indicative; Stark s.r.l. reserves the right, without notice, to make minor changes to the products and / or technical and aesthetic improvements.

MARZO 2017

www.starksicurezza.com
info@starksicurezza.com



Stark s.r.l.
Via Chiare, 1/A
12032 Barge (Cn) - Italia
Tel. 0175.349015 - Fax 0175.349749